



WARD FITTINGS

PRICE SCHEDULE #301014

EFFECTIVE: OCTOBER 27, 2014



WARD MFG

117 Gulick Street, Blossburg, PA 16912 | www.wardmfg.com | (800) 248-1027

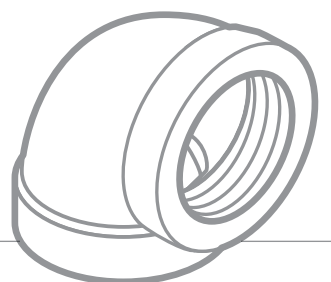

TERMS AND CONDITIONS OF SALE:

1. **PRICES:** This price sheet supersedes all previous issues. Prices in price sheets are subject to change without notice. Prices apply only to standard sizes as listed in catalog.
2. **APPROVAL & ACCEPTANCE OF ORDERS:** All orders are accepted on the basis of prices in effect at the time of shipment.
3. **TAXES:** Any Manufacturer or Sales Tax payable on the transaction under any effective statute will be added to the prices and terms quoted, unless a valid exemption certificate is on file.
4. **CREDIT TERMS:** Two percent cash discount tenth prox., - Net 30 days. Unless otherwise stated.
5. **DELIVERY & SHIPMENT OF GOODS:** All goods are shipped at buyer's risk. Shipments should be carefully examined upon delivery and before the carrier's delivery receipt is signed. If any loss or damage is evident, the buyer should make an appropriate notation on the delivery receipt and insist that the carrier's driver initial such exception. The contents of all packages should be carefully examined for concealed damage as soon as possible after delivery, so that the carrier can be requested, within 48 hours after delivery, to arrange for prompt inspection of the damaged goods. Completion of all orders accepted and fulfillment of all agreements or contracts entered into are subject to any delay which might be occasioned by labor disputes, fires, accidents, embargoes, trade restrictions, governmental directives or other causes beyond our control. All promises of shipment will be as closely estimated as possible. We use our efforts in every case to ship within the time promised, but cannot guarantee to do so. All claims for shortage must be made on receipt of goods. We prove our count by weighing the package. Claims for shortage are subject to that test. Typographical, clerical, arithmetical errors or omissions in orders, invoices, quotations, price schedules, acknowledgments, or other documents are subject to correction.
6. **RETURN OF GOODS:** No goods will be taken back and credited without prior approval and issuance of a return goods authorization (RGA) number. All fittings returned with our permission must be goods sold by Ward Manufacturing, LLC, and in clean saleable condition. Credit will only be allowed on the basis of prices agreed upon. If product returned is a result of a customer ordering error or overstocking situation, the credit will be less 20 percent to cover handling costs, less any costs of returning to a saleable condition, and less transportation charges on original and return shipments. Orders for special goods are not subject to cancellation for any reason after work has been started on them, except upon agreement to make payment for all work which has been performed.
7. **WARRANTY:** Seller warrants the material to be free of defects in material and workmanship, under normal use, proper maintenance and proper operation, for a period of one year from date of delivery to a common carrier for shipment to buyer or his designated agent. The obligation of the seller is limited to (1) repair of the material, or (2) replacement of any component or components proven defective in material or workmanship, or (3) refund of the purchase price. Seller shall have no liability for the cost of removal or reinstallation with respect to any replaced or repaired product. The election of said remedies shall be determined by seller in its sole discretion and shall be considered final disposition. All implied warranties, including the implied warranties of merchantability and fitness for a particular purpose, are hereby disclaimed and excluded. This warranty is in lieu of all other warranties, guarantees, agreements and similar obligations of seller; in no event shall seller be liable for consequential or incidental damages.
8. **FREIGHT TERM:** Shipments of 2,000 lb. net or more will be prepaid in the continental U.S. (except Alaska). We reserve the right to choose shipping point and carrier.
9. **CARTON & BOX QUANTITY ADJUSTMENT:** On orders received for less than master carton or box quantities, we reserve the right to adjust to the next carton or box quantity above the number of pieces shown on the order. Items subject to adjustment are identified with stars in the price sheet.
10. **WEIGHTS:** The weights per piece or per 100 pieces given in the price sheet, catalogs, and quotations are not guaranteed, but are approximate and for your convenience.
 - **SPECIAL CONDITIONS:** Any additional cost incurred in packaging or in making any special tests or inspection requested by Buyer in addition to those commercially supplied by Ward Manufacturing, LLC., will be charged to Buyer. Such tests and inspections will be made at the factory before date of shipment. Orders for fittings or parts will be subject to a net minimum invoice charge of \$50.00 Net plus applicable handling and freight charges.
 - **US EXPORT COMPLIANCE:** The products sold by Ward Manufacturing, LLC. may be subject to the export control laws and regulations of the United States Government. Buyer may not make any disposition of such products, by way of sale, export, re-export, transshipment or otherwise, except as permitted under applicable U.S. law.



Fig. 47

**MALLEABLE IRON
90° ELBOWS
CLASS 150**

DESCRIPTION	PCS PER BOX	PCS PER MASTER	WEIGHT PER 100	PART # BLACK	PRICE (US\$) BLACK	PART # GALV.	PRICE (US\$) GALV.		
1/8	35	210	8	A.BML	*	7.17	A.NML	*	11.11
1/4	30	180	12	B.BML	*	7.00	B.NML	*	10.14
3/8	30	180	19	C.BML	*	7.00	C.NML	*	10.14
1/2	50	200	26	D.BML	#	4.85	D.NML	#	6.53
3/4	35	140	45	E.BML	#	5.85	E.NML	#	8.02
1	20	80	69	1.BML	#	10.17	1.NML	#	14.85
1-1/4	20	40	102	1B.BML	#	16.77	1B.NML	*	23.47
1-1/2	8	32	135	1D.BML	#	22.06	1D.NML	*	30.63
2	8	16	219	2.BML	#	38.03	2.NML	*	50.18
2-1/2	12	12	449	2D.BML	*	84.72	2D.NML	*	131.31
3	5	5	737	3.BML	*	123.98	3.NML	*	216.49
3-1/2	3	6	665	3D.BML	*	340.82	3D.NML	*	707.87
4	4	4	919	4.BML	*	266.31	4.NML	*	381.83
5	1	1	1355	5.BML	*	778.19	5.NML	*	1648.96
6	1	1	2255	6.BML	*	898.91	6.NML	*	1520.16
1/4 x 1/8	30	180	10	BXA.BML	*	13.94	BXA.NML	*	18.20
3/8 x 1/8	25	75	15	CXA.BML	*	19.40	CXA.NML	*	30.90
3/8 x 1/4	25	150	16	CXB.BML	*	9.84	CXB.NML	*	16.22
1/2 x 3/8	50	200	24	DXC.BML	*	9.24	DXC.NML	*	12.01
1/2 x 1/4	30	180	22	DXB.BML	*	9.51	DXB.NML	*	14.06
3/4 x 1/4	12	24	28	EXB.BML	*	14.81	EXB.NML	*	25.46
3/4 x 1/2	30	120	35	EXD.BML	*	9.51	EXD.NML	*	13.94
3/4 x 3/8	30	180	30	EXC.BML	*	13.29	EXC.NML	*	19.23
1 x 3/4	20	80	56	1XE.BML	*	12.22	1XE.NML	*	17.89
1 x 1/2	25	100	50	1XD.BML	*	13.18	1XD.NML	*	18.99
1 x 3/8	25	100	47	1XC.BML	*	25.94	1XC.NML	*	33.70
1-1/4 x 1	10	40	83	1BX1.BML	*	20.53	1BX1.NML	*	30.01
1-1/4 x 3/4	15	60	74	1BXE.BML	*	22.90	1BXE.NML	*	36.05
1-1/4 x 1/2	15	60	65	1BXD.BML	*	26.76	1BXD.NML	*	38.20
1-1/2 x 1-1/4	15	30	120	1DX1B.BML	*	28.97	1DX1B.NML	*	47.96
1-1/2 x 1	10	40	106	1DX1.BML	*	28.97	1DX1.NML	*	47.96
1-1/2 x 3/4	12	48	89	1DXE.BML	*	33.14	1DXE.NML	*	47.96
1-1/2 x 1/2	12	48	79	1DXD.BML	*	31.88	1DXD.NML	*	41.43
2 x 1-1/2	10	20	172	2X1D.BML	*	41.96	2X1D.NML	*	56.03
2 x 1-1/4	10	20	162	2X1B.BML	*	47.69	2X1B.NML	*	64.23
2 x 1	12	24	134	2X1.BML	*	47.69	2X1.NML	*	66.65
2 x 3/4	15	30	140	2XE.BML	*	50.56	2XE.NML	*	67.99
2 x 1/2	10	40	121	2XD.BML	*	40.07	2XD.NML	*	53.63
2-1/2 x 2	12	12	312	2DX2.BML	*	115.17	2DX2.NML	*	189.93
2-1/2 x 1-1/2	12	12	256	2DX1D.BML	*	121.95	2DX1D.NML	*	211.60
3 x 2	8	8	382	3X2.BML	*	186.19	3X2.NML	*	299.81
3 x 2-1/2	5	5	423	3X2D.BML	*	215.53	3X2D.NML	*	345.20
4 x 3	4	4	738	4X3.BML	*	368.35	4X3.NML	*	781.15



Fig. 48

**MALLEABLE IRON
45° ELBOWS
CLASS 150**

DESCRIPTION	PCS PER BOX	PCS PER MASTER	WEIGHT PER 100	PART # BLACK	PRICE (US\$) BLACK	PART # GALV.	PRICE (US\$) GALV.		
1/8	35	210	8	A.BM45L	*	10.55	A.NM45L	*	16.34
1/4	35	210	13	B.BM45L	*	10.55	B.NM45L	*	13.83
3/8	40	240	17	C.BM45L	*	10.55	C.NM45L	*	15.45
1/2	50	200	26	D.BM45L	*	8.01	D.NM45L	*	10.33
3/4	40	160	38	E.BM45L	*	9.91	E.NM45L	*	14.85
1	25	100	56	1.BM45L	*	12.48	1.NM45L	*	16.77
1-1/4	10	40	90	1B.BM45L	*	22.07	1B.NM45L	*	31.33
1-1/2	10	40	122	1D.BM45L	*	27.30	1D.NM45L	*	36.80
2	8	16	187	2.BM45L	*	41.29	2.NM45L	*	54.45
2-1/2	15	15	320	2D.BM45L	*	119.48	2D.NM45L	*	189.46
3	8	8	451	3.BM45L	*	155.19	3.NM45L	*	275.55
4	4	4	719	4.BM45L	*	304.30	4.NM45L	*	461.94
5	1	1	1120	5.BM45L	*	1202.04	5.NM45L	*	1866.64
6	1	1	1910	6.BM45L	*	1229.82	6.NM45L	*	2250.73

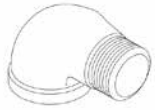

**MALLEABLE IRON
90° STREET ELLS
CLASS 150**

Fig. 50

DESCRIPTION	PCS PER BOX	PCS PER MASTER	WEIGHT PER 100	PART # BLACK	PRICE (US\$) BLACK	PART # GALV.	PRICE (US\$) GALV.
1/8	40	240	7	A.BMSL	*	10.34	A.NMSL
1/4	30	180	11	B.BMSL	*	10.34	B.NMSL
3/8	30	180	18	C.BMSL	*	10.34	C.NMSL
1/2	50	200	27	D.BMSL	#	10.03	D.NMSL
3/4	35	140	43	E.BMSL	#	10.03	E.NMSL
1	20	80	60	1.BMSL	#	14.21	1.NMSL
1-1/4	15	30	106	1B.BMSL	*	22.07	1B.NMSL
1-1/2	12	24	143	1D.BMSL	*	29.53	1D.NMSL
2	8	16	236	2.BMSL	*	47.99	2.NMSL
2-1/2	8	8	358	2D.BMSL		121.65	2D.NMSL
3	8	8	705	3.BMSL		185.69	3.NMSL
4	1	1	1065	4.BMSL		348.69	4.NMSL
1/2 x 3/8	35	280	22	DXC.BMSL		14.85	DXC.NMSL
3/4 x 1/2	25	100	36	EXD.BMSL		22.16	EXD.NMSL
1 x 3/4	25	100	56	1XE.BMSL		20.83	1XE.NMSL
1-1/4x3/4	15	60	75	1BXE.BMSL		57.24	1BXE.NMSL
1-1/4x1	15	30	101	1BX1.BMSL		29.97	1BX1.NMSL
1-1/2x1	15	30	134	1DX1.BMSL		44.02	1DX1.NMSL
1-1/2 x 1-1/4	16	32	140	1DX1B.BMSL	*	53.63	1DX1B.NMSL
2x1-1/2	12	24	19	2X1D.BMSL		76.81	2X1D.NMSL



**MALLEABLE IRON
45° STREET ELLS
CLASS 150**

Fig. 51

DESCRIPTION	PCS PER BOX	PCS PER MASTER	WEIGHT PER 100	PART # BLACK	PRICE (US\$) BLACK	PART # GALV.	PRICE (US\$) GALV.
1/8	30	180	7	A.BMS45L	*	16.27	A.NMS45L
1/4	25	150	10	B.BMS45L		13.52	B.NMS45L
3/8	30	180	15	C.BMS45L	*	13.72	C.NMS45L
1/2	50	200	21	D.BMS45L	*	11.20	D.NMS45L
3/4	40	160	32	E.BMS45L	*	16.91	E.NMS45L
1	25	100	55	1.BMS45L	*	19.70	1.NMS45L
1-1/4	25	50	86	1B.BMS45L	*	34.05	1B.NMS45L
1-1/2	15	30	109	1D.BMS45L	*	43.91	1D.NMS45L
2	10	20	170	2.BMS45L	*	73.84	2.NMS45L



**MALLEABLE IRON
TEES
CLASS 150**

Fig. 52

DESCRIPTION	PCS PER BOX	PCS PER MASTER	WEIGHT PER 100	PART # BLACK	PRICE (US\$) BLACK	PART # GALV.	PRICE (US\$) GALV.
1/8	35	210	13	A.BMT	*	10.80	A.NMT
1/8 x 1/4	25	50	12	AXB.BMT		20.11	AXB.NMT
1/4	35	210	17	B.BMT	*	10.17	B.NMT
1/4 x 1/8	25	50	13	BXA.BMT		21.05	BXA.NMT
1/4 x 1/4 x 3/8	15	30	19	BXC.BMT		22.77	BXC.NMT
3/8	30	180	26	C.BMT	*	10.17	C.NMT
3/8 x 3/8 x 1/4	15	30	21	CXB.BMT		16.00	CXB.NMT
3/8 x 1/4 x 1/4	15	30	19	CXBXB.BMT		24.63	CXBXB.NMT
1/2	30	120	37	D.BMT	#	6.49	D.NMT
3/4	20	80	60	E.BMT	#	9.31	E.NMT
3/4 x 3/8 x 3/8	35	140	36	EXXC.BMT		58.77	
3/4 x 3/4 x 1-1/4	10	40	88	EX1B.BMT		46.49	EX1B.NMT
1	12	48	91	1.BMT	#	15.94	1.NMT
1-1/4	15	30	138	1B.BMT	*	25.82	1B.NMT
1-1/2	10	20	184	1D.BMT	*	32.10	1D.NMT
2	15	15	312	2.BMT	*	54.72	2.NMT
2-1/2	8	8	494	2D.BMT		117.98	2D.NMT
3	6	6	722	3.BMT		173.79	3.NMT
4	3	3	1215	4.BMT		420.03	4.NMT
1/2 x 1/2 x 3/8	35	140	36	DXC.BMT	*	14.17	DXC.NMT
1/2 x 1/2 x 1/4	25	100	29	DXB.BMT	*	11.04	DXB.NMT
1/2 x 3/8 x 1/2	35	140	36	DXCXD.BMT	*	17.27	DXCXD.NMT
1/2 x 3/8 x 3/8	35	140	32	DXCXC.BMT	*	17.27	DXCXC.NMT
1/2 x 1/4 x 1/2	35	140	32	DXBXD.BMT		11.60	DXBXD.NMT



Fig. 52

**MALLEABLE IRON
TEES
CLASS 150
(continued)**

DESCRIPTION	PCS PER BOX	PCS PER MASTER	WEIGHT PER 100	PART # BLACK		PRICE (US\$) BLACK	PART # GALV.		PRICE (US\$) GALV.
3/8 x 3/8 x 1/2	30	180	34	CXD.BMT	*	15.10	CXD.NMT		20.04
3/4 x 3/4 x 1/2	25	100	52	EXD.BMT	*	14.40	EXD.NMT	*	19.39
3/4 x 3/4 x 3/8	30	120	49	EXC.BMT	*	17.68	EXC.NMT		20.85
3/4 x 3/4 x 1/4	30	120	43	EXB.BMT	*	16.00	EXB.NMT		20.71
3/4 x 1/2 x 3/4	20	80	54	EXDXE.BMT	*	16.62	EXDXE.NMT	*	22.13
3/4 x 1/2 x 1/2	30	120	45	EXDXD.BMT	*	14.79	EXDXD.NMT	*	23.18
3/4 x 3/8 x 3/4	25	100	53	EXCXE.BMT		44.47			
3/4 x 1/4 x 3/4	30	120	48	EXBXE.BMT	*	22.07	EXBXE.NMT		30.24
3/4 x 3/4 x 1	15	60	73	EX1.BMT	*	21.93	EX1.NMT	*	33.38
1/2 x 1/2 x 3/4	30	120	46	DXE.BMT		16.62	DXE.NMT	*	23.18
1/2 x 1/2 x 1	25	100	65	DX1.BMT	*	27.18	DX1.NMT		38.94
1 x 1 x 3/4	25	50	79	1XE.BMT	*	18.17	1XE.NMT	*	27.23
1 x 1 x 1/2	15	60	71	1XD.BMT	*	18.17	1XD.NMT	*	27.23
1 x 1 x 3/8	20	80	66	1XC.BMT		25.55	1XC.NMT		34.73
1 x 1 x 1/4	20	80	63	1XB.BMT	*	23.01	1XB.NMT		37.88
1 x 1 x 1-1/4	15	30	123	1X1B.BMT		40.23	1X1B.NMT		55.03
1 x 1 x 1-1/2	8	16	113	1X1D.BMT	*	65.94	1X1D.NMT		102.41
1 x 3/4 x 1	20	40	82	1XEX1.BMT	*	21.10	1XEX1.NMT	*	34.01
1 x 3/4 x 3/4	20	40	71	1XEXE.BMT	*	19.23	1XEXE.NMT	*	32.81
1 x 3/4 x 1/2	20	40	68	1XEXD.BMT	*	20.81	1XEXD.NMT	*	34.01
1 x 1/2 x 1	15	60	76	1XD1.BMT	*	20.70	1XD1.NMT		34.01
1 x 1/2 x 3/4	20	80	65	1DXE.BMT	*	24.69	1DXE.NMT		34.73
1 x 1/2 x 1/2	20	80	54	1DXD.BMT	*	20.70	1DXD.NMT		34.01
1 x 1/4 x 1	15	60	73	1XB1.BMT		21.10	1XB1.NMT		35.24
1 x 1 x 2	12	24	170	1X2.BMT	*	84.81	1X2.NMT		106.35
1-1/4 x 3/4 x 1-1/4	15	30	125	1BXEX1B.BMT	*	34.95	1BXEX1B.NMT		50.20
1-1/4 x 3/4 x 1	10	40	119	1BXEX1.BMT	*	35.71	1BXEX1.NMT		55.36
1-1/4 x 3/4 x 3/4	10	40	98	1BXEXE.BMT		38.57	1BXEXE.NMT		58.23
1-1/4 x 1/2 x 1	10	40	94	1BXDX1.BMT	*	45.02	1BXDX1.NMT		66.68
1-1/4 x 1/2 x 1-1/4	10	40	119	1BXDX1B.BMT		38.57	1BXDX1B.NMT		53.52
1-1/4 x 1-1/4 x 3/8	10	40	85	1BXC.BMT	*	45.02	1BXC.NMT		71.06
1-1/4 x 1-1/4 x 1	14	28	116	1BX1.BMT	*	31.47	1BX1.NMT	*	42.23
1-1/4 x 1-1/4 x 3/4	12	24	109	1BXE.BMT	*	29.04	1BXE.NMT	*	42.23
1-1/4 x 1-1/4 x 1/2	15	30	99	1BXD.BMT	*	33.12	1BXD.NMT	*	44.63
1-1/4 x 1 x 1-1/4	15	30	123	1BX1X1B.BMT	*	40.72	1BX1X1B.NMT		54.18
1-1/4 x 1 x 1	15	30	109	1BX1X1.BMT		33.91	1BX1X1.NMT	*	51.24
1-1/4 x 1 x 3/4	15	30	98	1BX1XE.BMT	*	33.91	1BX1XE.NMT	*	53.52
1-1/4 x 1 x 1/2	15	60	86	1BX1XD.BMT	*	41.99	1BX1XD.NMT		56.86
1-1/4 x 1-1/4 x 1-1/2	10	20	153	1BX1D.BMT	*	50.73	1BX1D.NMT		75.21
1-1/4 x 2	12	24	183	1BX2.BMT		84.81	1BX2.NMT		106.35
1-1/2 x 3/4 x 1-1/2	10	20	153	1DXEX1D.BMT	*	46.09	1DXEX1D.NMT		67.11
1-1/2 x 3/4 x 3/4	10	40	108	1DXEXE.BMT	*	77.26	1DXEXE.NMT		97.95
1-1/2 x 1/2 x 1-1/2	10	20	154	1DXDX1D.BMT	*	46.09	1DXDX1D.NMT		73.59
1-1/2 x 1 x 1-1/4	15	30	142	1DX1X1B.BMT		59.72	1DX1X1B.NMT		82.56
1-1/2 x 1-1/2 x 1-1/4	8	16	175	1DX1B.BMT	*	45.33	1DX1B.NMT	*	65.32
1-1/2 x 1-1/2 x 1	10	20	149	1DX1.BMT	*	36.65	1DX1.NMT	*	52.17
1-1/2 x 1-1/2 x 3/4	10	20	132	1DXE.BMT	*	36.65	1DXE.NMT	*	52.17
1-1/2 x 1-1/2 x 1/2	8	32	121	1DXD.BMT	*	38.80	1DXD.NMT	*	55.13
1-1/2 x 1-1/4 x 1-1/2	10	20	180	1DX1BX1D.BMT	*	69.50	1DX1BX1D.NMT		93.02
1-1/2 x 1-1/4 x 1-1/4	10	20	163	1DX1BX1B.BMT	*	61.83	1DX1BX1B.NMT		93.02
1-1/2 x 1-1/4 x 1	8	16	151	1DX1BX1.BMT	*	39.57	1DX1BX1.NMT	*	63.41
1-1/2 x 1-1/4 x 3/4	10	20	135	1DX1BXE.BMT	*	46.09	1DX1BXE.NMT	*	67.11
1-1/2 x 1-1/4 x 1/2	10	20	111	1DX1BXD.BMT		50.73	1DX1BXD.NMT		77.41
1-1/2 x 1 x 1-1/2	10	20	165	1DX1X1D.BMT	*	46.09	1DX1X1D.NMT	*	67.11
1-1/2 x 1 x 1	10	20	135	1DX1X1.BMT	*	46.09	1DX1X1.NMT		67.11
1-1/2 x 1-1/2 x 2	8	16	220	1DX2.BMT	*	81.70	1DX2.NMT	*	102.60
2 x 2 x 1-1/2	8	16	247	2X1D.BMT	*	61.83	2X1D.NMT	*	89.67
2 x 2 x 1-1/4	8	16	229	2X1B.BMT	*	61.83	2X1B.NMT	*	89.67
2 x 2 x 1	10	20	198	2X1.BMT	*	57.44	2X1.NMT	*	74.74
2 x 2 x 3/4	10	20	181	2XE.BMT	*	57.44	2XE.NMT	*	76.16
2 x 2 x 1/2	10	20	172	2XD.BMT	*	58.53	2XD.NMT	*	84.86
2 x 1-1/2 x 2	6	12	259	2X1DX2.BMT	*	77.77	2X1DX2.NMT	*	94.87
2 x 1-1/2 x 1-1/2	8	16	235	2X1DX1D.BMT	*	70.62	2X1DX1D.NMT		93.06
2 x 1-1/2 x 1-1/4	8	16	208	2X1DX1B.BMT	*	71.99	2X1DX1B.NMT		94.87
2 x 1-1/2 x 1	8	16	194	2X1DX1.BMT	*	70.62	2X1DX1.NMT	*	89.60
2 x 1-1/4 x 2	8	16	267	2X1BX2.BMT	*	77.19	2X1BX2.NMT	*	109.56



Fig. 52

**MALLEABLE IRON
TEES
CLASS 150
(continued)**

DESCRIPTION	PCS PER BOX	PCS PER MASTER	WEIGHT PER 100	PART # BLACK	PRICE (US\$) BLACK	PART # GALV.	PRICE (US\$) GALV.	
2 x 1-1/4 x 1-1/4	8	16	197	2X1BX1B.BMT	*	71.86	2X1BX1B.NMT	94.87
2 x 1-1/4 x 1-1/2	10	20	195	2X1BX1D.BMT		91.66	2X1BX1D.NMT	140.50
2 x 1 x 2	8	16	245	2X1X2.BMT	*	71.86	2X1X2.NMT	* 94.87
2 x 1 x 1	8	16	176	2X1X1.BMT	*	81.79	2X1X1.NMT	93.24
2 x 3/4 x 2	8	16	229	2XEX2.BMT	*	70.62	2XEX2.NMT	* 93.06
2 x 1/2 x 2	8	16	230	2DX2.BMT	*	71.86	2DX2.NMT	94.87
2 x 2 x 2-1/2	6	12	340	2X2D.BMT		183.81	2X2D.NMT	317.69
2-1/2 x 1-1/2 x 2	6	12	343	2DX1DX2.BMT		242.28	2DX1DX2.NMT	372.93
2-1/2 x 1-1/2 x 2-1/2	6	12	390	2DX1DX2D.BMT		183.81	2DX1DX2D.NMT	372.93
2-1/2 x 2 x 2	6	12	305	2DX2X2.BMT		177.13	2DX2X2.NMT	286.97
2-1/2 x 2 x 2-1/2	4	8	410	2DX2X2D.BMT		184.35	2DX2X2D.NMT	317.69
2-1/2 x 2-1/2 x 2	12	12	410	2DX2.BMT		153.48	2DX2.NMT	252.10
2-1/2 x 2-1/2 x 1-1/2	6	12	368	2DX1D.BMT		178.96	2DX1D.NMT	280.71
2-1/2 x 2-1/2 x 1-1/4	6	12	340	2DX1B.BMT		178.96	2DX1B.NMT	279.07
2-1/2 x 2-1/2 x 1	6	12	321	2DX1.BMT		178.96	2DX1.NMT	269.00
2-1/2 x 2-1/2 x 3/4	6	12	303	2DXE.BMT		172.36	2DXE.NMT	279.07
2-1/2 x 2-1/2 x 3	4	8	582	2DX3.BMT		324.13	2DX3.NMT	506.52
3-1/2	1	4	900	3D.BMT		402.39	3D.NMT	572.98
3 x 2 x 3	4	8	699	3X2X3.BMT		246.18	3X2X3.NMT	431.48
3 x 2-1/2 x 2	4	8	483	3X2DX2.BMT		324.13	3X2DX2.NMT	506.52
3 x 2-1/2 x 2-1/2	4	8	575	3X2DX2D.BMT		324.13	3X2DX2D.NMT	506.52
3 x 3 x 2-1/2	8	8	601	3X2D.BMT		243.51	3X2D.NMT	384.22
3 x 3 x 2	8	8	573	3X2.BMT		204.99	3X2.NMT	329.88
3 x 3 x 1-1/2	8	8	512	3X1D.BMT		213.11	3X1D.NMT	342.22
3 x 3 x 1-1/4	8	8	500	3X1B.BMT		217.02	3X1B.NMT	348.88
3 x 3 x 1	8	8	436	3X1.BMT		205.98	3X1.NMT	329.88
3 x 3 x 3/4	8	8	416	3XE.BMT		208.99	3XE.NMT	460.23
3 x 2 x 2	8	8	415	3X2X2.BMT		216.87	3X2X2.NMT	348.88
4 x 1-1/2	3	3	720	4X1D.BMT		497.13	4X1D.NMT	782.04
4 x 2	3	3	822	4X2.BMT		483.43	4X2.NMT	734.24
4 x 2-1/2	4	4	915	4X2D.BMT		557.39	4X2D.NMT	1013.03
4 x 4 x 3	3	3	1174	4X3.BMT		497.13	4X3.NMT	918.03
4 x 3 x 4	4	4	1030	4X3X4.BMT		654.00	4X3X4.NMT	1011.33
6	1	1	2550	6.BMT		1366.00	6.NMT	2013.05



Fig. 64

**MALLEABLE IRON
STREET TEES
CLASS 150**

DESCRIPTION	PCS PER BOX	PCS PER MASTER	WEIGHT PER 100	PART # BLACK	PRICE (US\$) BLACK	PART # GALV.	PRICE (US\$) GALV.	
1/4	25	50	15	B.BMST		20.83	B.NMST	29.89
1/2	15	120	35	D.BMST		19.18	D.NMST	31.66
3/4	20	80	58	E.BMST	*	23.72	E.NMST	* 30.34
3/8	12	24	25	C.BMST		23.22	C.NMST	33.43
1	12	24	98	1.BMST	*	31.35	1.NMST	* 47.98
1-1/4	10	20	162	1B.BMST	*	51.76	1B.NMST	* 80.02
1-1/4 x 1 x 1-1/4	8	16	128	1BX1X1B.BMST		75.79	1BX1X1B.NMST	114.59
1-1/2	12	24	197	1D.BMST		80.71	1D.NMST	121.98
2	6	12	316	2.BMST		148.61	2.NMST	233.53



Fig. 61

**MALLEABLE IRON
CROSSES
CLASS 150**

DESCRIPTION	PCS PER BOX	PCS PER MASTER	WEIGHT PER 100	PART # BLACK	PRICE (US\$) BLACK	PART # GALV.	PRICE (US\$) GALV.	
1/8	25	50	13	A.BMCR		29.65	A.NMCR	48.44
1/4	15	90	20	B.BMCR		23.62	B.NMCR	38.66
3/8	20	160	28	C.BMCR		24.46	C.NMCR	40.14
1/2	30	120	45	D.BMCR	*	24.53	D.NMCR	* 34.81
3/4	15	60	73	E.BMCR	*	29.68	E.NMCR	* 42.41
1	15	30	109	1.BMCR	*	36.57	1.NMCR	* 58.52
1-1/4	12	24	188	1B.BMCR	*	59.35	1B.NMCR	* 87.98
1-1/2	8	16	231	1D.BMCR	*	73.55	1D.NMCR	* 102.93
2	8	8	336	2.BMCR	*	120.93	2.NMCR	* 194.96
2-1/2	4	8	533	2D.BMCR		257.48	2D.NMCR	521.30
3	4	4	834	3.BMCR		357.22	3.NMCR	576.06
4	1	1	1290	4.BMCR		782.45	4.NMCR	1418.55



**MALLEABLE IRON
STRT & RED PIPE
COUPLINGS
CLASS 150**

Fig. 53

DESCRIPTION	PCS PER BOX	PCS PER MASTER	WEIGHT PER 100	PART # BLACK	PRICE (US\$) BLACK	PART # GALV.	PRICE (US\$) GALV.
1/8 (steel)	40	240	3	A.BSMC	*	10.09	A.NSMC
1/4	35	210	11	B.BMC	*	8.70	B.NMC
3/8	40	240	16	C.BMC	*	8.70	C.NMC
1/2	40	240	21	D.BMC	*	6.71	D.NMC
3/4	40	160	33	E.BMC	*	7.86	E.NMC
1	25	100	48	1.BMC	#	11.77	1.NMC
1-1/4	15	60	74	1B.BMC	*	15.24	1B.NMC
1-1/2	10	40	98	1D.BMC	*	20.59	1D.NMC
2	8	32	154	2.BMC	*	30.50	2.NMC
2-1/2	8	8	262	2D.BMC	*	84.19	2D.NMC
3	8	8	391	3.BMC	*	113.81	3.NMC
4	4	4	610	4.BMC	*	229.21	4.NMC
1/4 x 1/8	25	150	9	BXA.BMC	*	9.17	BXA.NMC
3/8 x 1/4	25	150	12	CXB.BMC	*	9.17	CXB.NMC
3/8 x 1/8	30	180	18	CXA.BMC	*	11.73	CXA.NMC
1/2 x 3/8	30	180	17	DXC.BMC	*	7.88	DXC.NMC
1/2 x 1/4	25	150	16	DXB.BMC	*	8.33	DXB.NMC
1/2 x 1/8	25	150	16	DXA.BMC	*	9.27	DXA.NMC
3/4 x 1/2	50	200	28	EXD.BMC	*	8.81	EXD.NMC
3/4 x 3/8	35	210	25	EXC.BMC	*	10.52	EXC.NMC
3/4 x 1/4	35	210	23	EXB.BMC	*	10.52	EXB.NMC
3/4 x 1/8	35	210	23	EXA.BMC	*	10.96	EXA.NMC
1 x 3/4	25	100	43	1XE.BMC	*	13.72	1XE.NMC
1 x 1/2	30	120	49	1XD.BMC	*	14.05	1XD.NMC
1 x 3/8	30	120	38	1XC.BMC	*	17.28	1XC.NMC
1 x 1/4	30	120	38	1XB.BMC	*	18.50	1XB.NMC
1-1/4 x 1	15	60	70	1BX1.BMC	*	17.65	1BX1.NMC
1-1/4 x 3/4	15	60	64	1BXE.BMC	*	17.65	1BXE.NMC
1-1/4 x 1/2	15	60	63	1BXD.BMC	*	20.70	1BXD.NMC
1-1/2 x 1-1/4	10	40	96	1DX1B.BMC	*	22.31	1DX1B.NMC
1-1/2 x 1	10	40	89	1DX1.BMC	*	25.87	1DX1.NMC
1-1/2 x 3/4	10	40	87	1DXE.BMC	*	29.68	1DXE.NMC
1-1/2 x 1/2	15	60	80	1DXD.BMC	*	26.33	1DXD.NMC
2 x 1-1/2	10	20	146	2X1D.BMC	*	32.32	2X1D.NMC
2 x 1-1/4	10	20	139	2X1B.BMC	*	37.02	2X1B.NMC
2 x 1	15	30	127	2X1.BMC	*	34.98	2X1.NMC
2 x 3/4	8	32	138	2XE.BMC	*	37.02	2XE.NMC
2 x 1/2	8	32	141	2XD.BMC	*	42.87	2XD.NMC
2-1/2 x 2	10	10	249	2DX2.BMC	*	74.30	2DX2.NMC
2-1/2 x 1-1/2	10	10	233	2DX1D.BMC	*	88.16	2DX1D.NMC
2-1/2 x 1-1/4	20	20	207	2DX1B.BMC	*	95.55	2DX1B.NMC
2-1/2 x 1	20	20	224	2DX1.BMC	*	95.55	2DX1.NMC
3 x 2-1/2	8	8	378	3X2D.BMC	*	112.31	3X2D.NMC
3 x 2	8	8	334	3X2.BMC	*	96.18	3X2.NMC
3 x 1-1/2	8	8	305	3X1D.BMC	*	116.14	3X1D.NMC
3 x 1-1/4	8	8	337	3X1B.BMC	*	120.49	3X1B.NMC
3 x 1	8	8	325	3X1.BMC	*	118.29	3X1.NMC
3-1/2 x 2	4	8	423	3DX2.BMC	*	367.09	3DX2.NMC
3-1/2 x 3	4	8	475	3DX3.BMC	*	367.09	3DX3.NMC
4 x 1-1/2	1	1	495	4X1D.BMC	*	278.97	4X1D.NMC
4 x 2-1/2	4	4	571	4X2D.BMC	*	261.09	4X2D.NMC
4 x 2	4	4	524	4X2.BMC	*	232.80	4X2.NMC
4 x 3	4	4	621	4X3.BMC	*	232.80	4X3.NMC
4 x 3-1/2	4	4	620	4X3D.BMC	*	367.09	4X3D.NMC
5 x 4	1	1	940	5X4.BMC	*	523.26	5X4.NMC
6 x 4	1	1	1085	6X4.BMC	*	672.07	6X4.NMC



Fig. 60

**MALLEABLE IRON
RETURN BENDS
OPEN
CLASS 150**

DESCRIPTION	PCS PER BOX	PCS PER MASTER	WEIGHT PER 100	PART # BLACK	PRICE (US\$) BLACK	PART # GALV.	PRICE (US\$) GALV.
3/4	25	50	72	E.BMRB	52.74	E.NMRB	61.13
1	10	20	173	1.BMRB	49.01	1.NMRB	74.23

**MALLEABLE IRON
45 Y
CLASS 150**

DESCRIPTION	PCS PER BOX	PCS PER MASTER	WEIGHT PER 100	PART # BLACK	PRICE (US\$) BLACK	PART # GALV.	PRICE (US\$) GALV.
3/8	12	24	28	C.BM45Y	26.16	C.NM45Y	31.81
1/2	35	140	39	D.BM45Y	24.63	D.NM45Y	28.56
3/4	20	80	65	E.BM45Y	32.67	E.NM45Y	44.69
1	10	40	88	1.BM45Y	42.73	1.NM45Y	63.88
1-1/4	12	24	160	1B.BM45Y	73.84	1B.NM45Y	102.32
1-1/2	10	20	213	1D.BM45Y	103.14	1D.NM45Y	143.84
2	6	12	325	2.BM45Y	160.52	2.NM45Y	231.37
2-1/2	1	4	586	2D.BM45Y	408.89	2D.NM45Y	653.05
3	1	1	915	3.BM45Y	565.32	3.NM45Y	1073.78
4	1	1	1570	4.BM45Y	1191.32	4.NM45Y	1772.03



Fig. 49

**MALLEABLE IRON
CAPS
CLASS 150**

DESCRIPTION	PCS PER BOX	PCS PER MASTER	WEIGHT PER 100	PART # BLACK	PRICE (US\$) BLACK	PART # GALV.	PRICE (US\$) GALV.
1/4	40	240	6	B.BMCAP	* 6.45	B.NMCAP	* 8.77
3/8	40	240	10	C.BMCAP	* 5.41	C.NMCAP	* 8.77
1/2	50	300	17	D.BMCAP	* 4.90	D.NMCAP	* 7.24
3/4	40	240	24	E.BMCAP	* 6.64	E.NMCAP	* 10.01
1	25	150	42	1.BMCAP	* 8.03	1.NMCAP	* 12.41
1-1/4	25	100	62	1B.BMCAP	* 10.59	1B.NMCAP	* 16.34
1-1/2	20	80	83	1D.BMCAP	* 14.55	1D.NMCAP	* 20.94
2	10	40	129	2.BMCAP	* 21.23	2.NMCAP	* 29.33
2-1/2	6	12	189	2D.BMCAP	48.36	2D.NMCAP	85.19
3	6	12	291	3.BMCAP	* 71.86	3.NMCAP	103.24
3-1/2	8	16	322	3D.BMCAP	162.91	3D.NMCAP	283.36
4	5	10	566	4.BMCAP	123.21	4.NMCAP	228.09
5	4	8	740	5.BMCAP	293.68	5.NMCAP	611.97
6	3	3	995	6.BMCAP	538.33	6.NMCAP	773.40



Fig. 55

**MALLEABLE IRON
LOCKNUT
CLASS 150**

DESCRIPTION	PCS PER BOX	PCS PER MASTER	WEIGHT PER 100	PART # BLACK	PRICE (US\$) BLACK	PART # GALV.	PRICE (US\$) GALV.
1/8 (steel)	100	600	2	A.BSLN	6.35	A.NSLN	7.21
1/4 (steel)	100	600	3	B.BSLN	* 5.84	B.NSLN	* 5.84
3/8	50	300	4	C.BMLN	* 8.09	C.NMLN	10.14
1/2	50	300	7	D.BMLN	* 6.94	D.NMLN	8.20
3/4	50	300	10	E.BMLN	* 7.56	E.NMLN	9.61
1	40	160	16	1.BMLN	* 14.50	1.NMLN	17.48
1-1/4	40	160	22	1B.BMLN	* 11.91	1B.NMLN	16.77
1-1/2	40	160	27	1D.BMLN	* 16.74	1D.NMLN	21.77
2	25	100	55	2.BMLN	* 27.77	2.NMLN	38.33



Fig. 62

**MALLEABLE IRON
WASTE NUT
CLASS 150**

DESCRIPTION	PCS PER BOX	PCS PER MASTER	WEIGHT PER 100	PART # BLACK	PRICE (US\$) BLACK	PART # GALV.	PRICE (US\$) GALV.
1/2	50	300	10	D.BMWN	14.34	D.NMWN	16.51
3/4	50	300	12	E.BMWN	17.30	E.NMWN	23.47
1	25	150	15	1.BMWN	12.95	1.NMWN	17.37



**MALLEABLE IRON
EXTENSION PIECES
CLASS 150**

Fig. 54

DESCRIPTION	PCS PER BOX	PCS PER MASTER	WEIGHT PER 100	PART # BLACK	PRICE (US\$) BLACK	PART # GALV.	PRICE (US\$) GALV.	
1/2	50	200	23	D.BME	*	14.97	D.NME	24.10
3/4	50	200	32	E.BME	*	22.06	E.NME	36.05
1	25	100	49	1.BME	*	31.83	1.NME	45.21
1-1/4	15	60	93	1B.BME	*	36.63	1B.NME	48.48



**MALLEABLE IRON
FLOOR FLANGES
CLASS 150**

Fig. 15

DESCRIPTION	PCS PER BOX	PCS PER MASTER	WEIGHT PER 100	PART # BLACK	PRICE (US\$) BLACK	PART # GALV.	PRICE (US\$) GALV.
1/4 x 2-3/8	25	150	24	B.BMFF		B.NMFF	44.02
3/8 x 2-15/16	25	150	40	C.BMFF		C.NMFF	44.02
1/2 x 3	30	120	46	D.BMFF	*	D.NMFF	56.54
3/4 x 3-1/4	30	120	47	E.BMFF	*	E.NMFF	56.54
1 x 3-7/8	30	60	91	1.BMFF	*	1.NMFF	51.61
1-1/4 x 3-7/8	30	60	80	1B.BMFF	*	1B.NMFF	68.59
1-1/2 x 4-1/2	10	40	140	1D.BMFF	*	1D.NMFF	87.88
2 x 5-1/2	15	30	214	2.BMFF	*	2.NMFF	111.61
2-1/2 x 5-13/16	10	10	225	2D.BMFF		2D.NMFF	135.68
3 x 6-3/8	10	10	286	3.BMFF		3.NMFF	132.43



**MALLEABLE IRON
LEFT & RIGHT
HAND THREAD
COUPLINGS
CLASS 150**

Fig. 53

DESCRIPTION	PCS PER BOX	PCS PER MASTER	WEIGHT PER 100	PART # BLACK	PRICE (US\$) BLACK	PART # GALV.	PRICE (US\$) GALV.	
1/2	40	240	21	D.BMCLR	*	14.07	D.NMCLR	18.44
3/4	40	160	33	E.BMCLR	*	15.79	E.NMCLR	21.34
1	25	100	50	1.BMCLR	*	23.46	1.NMCLR	31.45
1-1/4	15	60	74	1B.BMCLR	*	27.83	1B.NMCLR	40.36
1-1/2	10	40	101	1D.BMCLR	*	37.94	1D.NMCLR	51.88
2	8	32	154	2.BMCLR	*	50.74	2.NMCLR	69.94



**MALLEABLE IRON
90° ELBOWS A.A.R.
CLASS 300**

Fig. 65

DESCRIPTION	PCS PER BOX	PCS PER MASTER	WEIGHT PER 100	PART # BLACK	PRICE (US\$) BLACK	PART # GALV.	PRICE (US\$) GALV.	
1/4	35	210	22	B.B300L	*	24.57	B.N300L	43.99
3/8	20	120	32	C.B300L	*	21.82	C.N300L	44.87
1/2	15	90	55	D.B300L	*	28.28	D.N300L	53.44
3/4	12	48	87	E.B300L	*	31.99	E.N300L	59.99
1	10	40	127	1.B300L	*	40.85	1.N300L	76.93
1-1/4	10	20	203	1B.B300L	*	59.61	1B.N300L	120.85
1-1/2	8	16	265	1D.B300L	*	70.29	1D.N300L	130.98
2	5	10	413	2.B300L	*	101.12	2.N300L	220.11
2-1/2	6	6	650	2D.B300L		262.07	2D.N300L	489.88
3	6	6	1032	3.B300L		300.95	3.N300L	577.79
3/8 x 1/4	25	150	25	CXB.B300L		50.39		
1/2 x 3/8	25	100	58	DXC.B300L		52.30	DXC.N300L	70.14
3/4 x 1/2	15	60	69	EXD.B300L		38.53	EXD.N300L	68.38
1 x 1/2	20	40	95	1XD.B300L		79.32	1XD.N300L	97.03
1 x 3/4	10	40	111	1XE.B300L		77.12	1XE.N300L	108.10
1-1/4x3/4	15	30	135	1BXE.B300L		139.12		
1-1/4x1	15	30	155	1BX1.B300L		96.89		
1-1/2x1	10	20	185	1DX1.B300L		152.98		
1-1/2x1-1/4	10	20	215	1DX1B.B300L		152.98		
2x1-1/4	5	10	302	2X1B.B300L		214.94		
2x1-1/2	5	10	333	2X1D.B300L		191.67	2X1D.N300L	398.03
4	1	1	1635	4.B300L		707.05	4.N300L	1726.78



Fig. 65A

**MALLEABLE IRON
45° ELBOWS A.A.R.
CLASS 300**

DESCRIPTION	PCS PER BOX	PCS PER MASTER	WEIGHT PER 100	PART # BLACK	PRICE (US\$) BLACK	PART # GALV.	PRICE (US\$) GALV.
1/4	35	210	23	B.B30045L			52.11
3/8	25	150	34	C.B30045L			52.11
1/2	20	80	51	D.B30045L	*		79.39
3/4	15	60	76	E.B30045L	*		91.78
1	10	40	119	1.B30045L	*		100.26
1-1/4	12	24	178	1B.B30045L	*		155.62
1-1/2	8	16	236	1D.B30045L	*		201.35
2	6	12	392	2.B30045L	*		278.91
2-1/2	4	8	530	2D.B30045L			745.24
3	3	6	825	3.B30045L			979.50
4	3	3	1341	4.B30045L			1415.15



Fig. 65B

**MALLEABLE IRON
STREET 90°
ELBOWS A.A.R.
CLASS 300**

DESCRIPTION	PCS PER BOX	PCS PER MASTER	WEIGHT PER 100	PART # BLACK	PRICE (US\$) BLACK	PART # GALV.	PRICE (US\$) GALV.
1/4	40	240	19	B.B300SL			46.29
3/8	35	140	31	C.B300SL			46.29
1/2	15	90	48	D.B300SL	*		90.71
3/4	12	48	76	E.B300SL	*		96.34
1	10	40	111	1.B300SL	*		125.98
1-1/4	12	24	176	1B.B300SL	*		164.56
1-1/2	10	20	133	1D.B300SL	*		211.55
2	6	12	376	2.B300SL	*		330.64
3	2	4	973	3.B300SL			



**MALLEABLE IRON
STREET 45°
ELBOWS A.A.R.
CLASS 300**

DESCRIPTION	PCS PER BOX	PCS PER MASTER	WEIGHT PER 100	PART # BLACK	PRICE (US\$) BLACK	PART # GALV.	PRICE (US\$) GALV.
1/2	50	200	38	D.B300S45L	*		130.09
3/4	25	100	62	E.B300S45L	*		137.80
1	15	60	89	1.B300S45L			161.60
1 1/4	10	40	150	1B.B300S45L			
1 1/2	6	24	206	1D.B300S45L			
2	8	16	334	2.B300S45L			



Fig. 66

**MALLEABLE IRON
TEES A.A.R.
CLASS 300**

DESCRIPTION	PCS PER BOX	PCS PER MASTER	WEIGHT PER 100	PART # BLACK	PRICE (US\$) BLACK	PART # GALV.	PRICE (US\$) GALV.
1/4	25	150	32	B.B300T			62.61
3/8	15	90	45	C.B300T			63.77
1/2	15	60	75	D.B300T	*		79.84
3/4	10	40	120	E.B300T	*		87.93
1	12	24	171	1.B300T	*		108.41
1-1/4	8	16	273	1B.B300T	*		154.73
1-1/2	6	12	369	1D.B300T	*		160.89
2	4	8	559	2.B300T	*		257.21
3	4	4	1305	3.B300T			921.79
3/8 x 1/4	18	108	43	CXB.B300T			64.78
1/2 x 3/8	15	60	68	DXC.B300T			108.17
1/2 x 1/4	20	80	58	DXB.B300T			108.17
3/4 x 1/4	15	60	73	EXB.B300T			
3/4 x 3/8	13	52	80	EXC.B300T			
3/4 x 1/2	10	40	100	EXD.B300T	*		116.78
3/4 x 1/2 x 1/2	1	1	78	EXDXD.B300T			
3/4 x 1/2 x 3/4	13	52	93	EXDXE.B300T			
1 x 1/2 x 1	18	36	130	1XDX1.B300T			
1 x 1/4	9	36	105	1XB.B300T			
1 x 3/4	7	28	155	1XE.B300T	*		153.39



Fig. 66

MALLEABLE IRON TEES A.A.R. CLASS 300 (continued)

DESCRIPTION	PCS PER BOX	PCS PER MASTER	WEIGHT PER 100	PART # BLACK	PRICE (US\$) BLACK	PART # GALV.	PRICE (US\$) GALV.
1 x 3/4 x 3/4	10	40	123	1XEXE.B300T	95.24		
1 x 3/4 x 1	9	36	136	1XEX1.B300T	106.89		
1 x 1/2	8	32	141	1XD.B300T	* 81.32	1XD.N300T	* 139.41
1-1/4 x 1/2	15	30	180	1BXD.B300T	124.31	1BXD.N300T	225.32
1-1/4 x 1	10	20	240	1BX1.B300T	* 112.36	1BX1.N300T	203.53
1-1/4 x 1 x 1	14	28	193	1BX1X1.B300T	124.31		
1-1/4 x 3/4	10	20	239	1BXE.B300T	108.26	1BXE.N300T	203.53
1-1/2 x 1	8	16	298	1DX1.B300T	* 131.73	1DX1.N300T	249.80
1-1/2 x 1-1/4	9	18	305	1DX1B.B300T	148.41	1DX1B.N300T	
1-1/2 x 1/2	10	20	249	1DXD.B300T	147.40	1DXD.N300T	253.55
1-1/2 x 3/4	9	18	262	1DXE.B300T	* 131.73	1DXE.N300T	249.80
2 x 1/2	6	12	363	2XD.B300T	* 212.38	2XD.N300T	* 398.44
2 x 3/4	8	16	386	2XE.B300T	212.38	2XE.N300T	398.44
2 x 1	6	12	421	2X1.B300T	212.38	2X1.N300T	336.72
2 x 1-1/4	6	12	425	2X1B.B300T	218.39	2X1B.N300T	480.99
2 x 1-1/2	5	10	483	2X1D.B300T	* 197.51	2X1D.N300T	370.09
2 x 1-1/2 x 2	5	10	470	2X1DX2.B300T	256.37		
2-1/2	4	4	840	2D.B300T	324.85	2D.N300T	813.12
2-1/2 x 1-1/2	4	8	653	2DX1D.B300T	364.00		
2-1/2 x 2	1	1	760	2DX2.B300T	0.00		
3 x 2	4	4	990	3X2.B300T	924.26	3X2.N300T	1658.68
4	1	1	2340	4.B300T	1319.65	4.N300T	2366.98



Fig. 68

MALLEABLE IRON CROSSES A.A.R. CLASS 300

DESCRIPTION	PCS PER BOX	PCS PER MASTER	WEIGHT PER 100	PART # BLACK	PRICE (US\$) BLACK	PART # GALV.	PRICE (US\$) GALV.
1/4	1	1	35	B.B300CR	83.49		
1/2	12	48	89	D.B300CR	116.20	D.N300CR	207.85
3/4	15	30	136	E.B300CR	* 137.04	E.N300CR	302.59
1	12	24	199	1.B300CR	149.48	1.N300CR	340.86
1-1/4	7	14	311	1B.B300CR	151.64	1B.N300CR	311.78
1-1/2	5	10	427	1D.B300CR	* 261.54	1D.N300CR	417.53
2	3	6	665	2.B300CR	* 284.79	2.N300CR	596.20



Fig. 67

MALLEABLE IRON COUPLINGS AND REDUCERS A.A.R. CLASS 300

DESCRIPTION	PCS PER BOX	PCS PER MASTER	WEIGHT PER 100	PART # BLACK	PRICE (US\$) BLACK	PART # GALV.	PRICE (US\$) GALV.
1/4	35	210	18	B.B300C	22.16	B.N300C	28.86
3/8	25	150	31	C.B300C	22.16	C.N300C	41.54
1/2	20	80	48	D.B300C	* 24.73	D.N300C	42.61
3/4	30	60	74	E.B300C	* 28.45	E.N300C	48.13
1	10	40	110	1.B300C	* 32.54	1.N300C	63.68
1-1/4	12	24	174	1B.B300C	* 38.69	1B.N300C	82.99
1-1/2	10	20	223	1D.B300C	* 57.94	1D.N300C	117.11
2	6	12	365	2.B300C	* 83.45	2.N300C	* 141.83
2-1/2	5	10	535	2D.B300C	153.69	2D.N300C	372.93
3/8 x 1/4	25	150	25	CXB.B300C	29.30	CXB.N300C	41.56
1/2 x 3/8	30	120	39	DXC.B300C	* 35.28	DXC.N300C	60.20
1/2 x 1/4	20	120	35	DXB.B300C	* 35.28	DXB.N300C	60.20
3/4 x 1/4	45	90	45	EXB.B300C	50.32		
3/4 x 3/8	45	90	47	EXC.B300C	50.32	EXC.N300C	96.64
3/4 x 1/2	20	80	55	EXD.B300C	* 36.07	EXD.N300C	73.07
1 x 1/4	15	60	67	1XB.B300C	60.32	1XB.N300C	117.70
1 x 1/2	15	60	78	1XD.B300C	* 43.95	1XD.N300C	89.05
1 x 3/4	12	48	83	1XE.B300C	* 43.09	1XE.N300C	87.28
1 x 3/8	20	80	65	1XC.B300C	60.32	1XC.N300C	117.70
1-1/4 x 1/2	22	44	107	1BXD.B300C	89.98	1BXD.N300C	144.17
1-1/4 x 3/4	15	30	123	1BXE.B300C	* 58.85	1BXE.N300C	109.09
1-1/4 x 1	18	36	134	1BX1.B300C	* 56.74	1BX1.N300C	99.18
1-1/2 x 1/2	16	32	147	1DXD.B300C	93.46	1DXD.N300C	178.74
1-1/2 x 1	14	28	166	1DX1.B300C	* 77.70	1DX1.N300C	135.18
1-1/2 x 3/4	15	30	159	1DXE.B300C	* 80.70	1DXE.N300C	135.18
1-1/2 x 1-1/4	12	24	189	1DX1B.B300C	* 88.38	1DX1B.N300C	149.14
2 x 1-1/4	6	12	275	2X1B.B300C	137.77	2X1B.N300C	288.67
2 x 1-1/2	8	16	292	2X1D.B300C	* 111.72	2X1D.N300C	193.44



**MALLEABLE IRON
COUPLINGS AND
REDUCERS A.A.R.
CLASS 300
(continued)**

Fig. 67

DESCRIPTION	PCS PER BOX	PCS PER MASTER	WEIGHT PER 100	PART # BLACK	PRICE (US\$) BLACK	PART # GALV.	PRICE (US\$) GALV.
2 x 1/2	12	24	228	2XD.B300C			134.88
2 x 3/4	10	20	235	2XE.B300C		2XE.N300C	285.97
2 x 1	8	16	264	2X1.B300C	*	2X1.N300C	216.73
2-1/2 x 1-1/2	4	8	388	2DX1D.B300C		2DX1D.N300C	527.77
2-1/2 x 2	5	10	437	2DX2.B300C		2DX2.N300C	527.77
3	3	6	713	3.B300C		3.N300C	443.97
3 x 1-1/2	4	8	560	3X1D.B300C			
3 x 2	4	8	566	3X2.B300C		3X2.N300C	798.06
3 x 2-1/2	4	8	643	3X2D.B300C		3X2D.N300C	798.06
4 x 2	1	1	920	4X2.B300C			
4 x 3	4	4	985	4X3.B300C			



**MALLEABLE IRON
CAPS A.A.R.
CLASS 300**

Fig. 69

DESCRIPTION	PCS PER BOX	PCS PER MASTER	WEIGHT PER 100	PART # BLACK	PRICE (US\$) BLACK	PART # GALV.	PRICE (US\$) GALV.
1/4	50	300	13	B.B300CAP		B.N300CAP	29.44
3/8	40	240	18	C.B300CAP		C.N300CAP	29.44
1/2	40	160	28	D.B300CAP		D.N300CAP	43.19
3/4	25	100	45	E.B300CAP	*	E.N300CAP	51.63
1	15	60	73	1.B300CAP	*	1.N300CAP	70.84
1-1/4	10	40	110	1B.B300CAP	*	1B.N300CAP	83.82
1-1/2	15	30	140	1D.B300CAP	*	1D.N300CAP	117.50
2	10	20	218	2.B300CAP	*	2.N300CAP	162.61
2-1/2	10	10	340	2D.B300CAP		2D.N300CAP	384.90
3	8	16	463	3.B300CAP		3.N300CAP	525.57

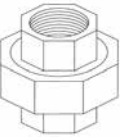

**MALLEABLE IRON
UNIONS BRASS
TO IRON
CLASS 150**

Fig. 91

DESCRIPTION	PCS PER BOX	PCS PER MASTER	WEIGHT PER 100	PART # BLACK	PRICE (US\$) BLACK	PART # GALV.	PRICE (US\$) GALV.
1/8	25	150	27	A.BU	*	A.NU	55.94
1/4	35	210	24	B.BU	*	B.NU	49.26
3/8	30	180	32	C.BU	*	C.NU	32.97
1/2	40	160	41	D.BU	#	D.NU	30.07
3/4	30	60	67	E.BU	#	E.NU	34.56
3/4 x 1/2	40	160	41	EXD.BU		EXD.NU	57.50
1	25	50	88	1.BU	#	1.NU	45.26
1-1/4	15	30	151	1B.BU	*	1B.NU	65.44
1-1/2	12	24	188	1D.BU	*	1D.NU	79.28
2	8	16	265	2.BU	*	2.NU	91.15
2-1/2	8	8	518	2D.BU		2D.NU	316.62
3	8	8	763	3.BU		3.NU	443.14
4	1	2	1451	4.BU		4.NU	897.81

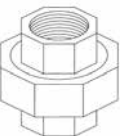

**MALLEABLE IRON
UNIONS BRASS
TO IRON
CLASS 250**

Fig. 92

DESCRIPTION	PCS PER BOX	PCS PER MASTER	WEIGHT PER 100	PART # BLACK	PRICE (US\$) BLACK	PART # GALV.	PRICE (US\$) GALV.
1/8	25	150	15	A.B250U		A.N250U	127.47
1/4	35	210	25	B.B250U		B.N250U	51.41
3/8	30	180	38	C.B250U		C.N250U	52.17
1/2	40	80	60	D.B250U	*	D.N250U	68.50
3/4	30	60	102	E.B250U	*	E.N250U	62.23
1	18	36	120	1.B250U	*	1.N250U	77.17
1-1/4	12	24	190	1B.B250U	*	1B.N250U	116.86
1-1/2	10	20	243	1D.B250U	*	1D.N250U	134.53
2	6	12	412	2.B250U	*	2.N250U	190.00
2-1/2	8	8	540	2D.B250U		2D.N250U	499.79
3	8	8	842	3.B250U		3.N250U	766.80
4	1	2	1451	4.B250U		4.N250U	1202.83

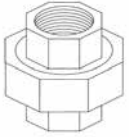

Fig. 93

MALLEABLE IRON UNIONS BRASS TO IRON A.A.R. CLASS 300

DESCRIPTION	PCS PER BOX	PCS PER MASTER	WEIGHT PER 100	PART # BLACK	PRICE (US\$) BLACK	PART # GALV.	PRICE (US\$) GALV.
1/8	25	150	15	A.B300U			64.91
1/4	35	210	25	B.B300U			72.06
3/8	30	180	38	C.B300U			73.49
1/2	40	80	57	D.B300U	*		69.69
3/4	30	60	109	E.B300U	*		75.56
1	18	36	129	1.B300U	*		100.24
1-1/4	12	24	208	1B.B300U	*		139.79
1-1/2	10	20	252	1D.B300U	*		168.31
2	6	12	428	2.B300U	*		202.03
2-1/2	8	8	541	2D.B300U			563.53
3	8	8	872	3.B300U			953.09
4	1	1	1730	4.B300U			2390.39

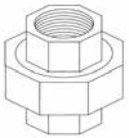

Fig. 94

MALLEABLE IRON UNIONS ALL IRON CLASS 150

DESCRIPTION	PCS PER BOX	PCS PER MASTER	WEIGHT PER 100	PART # BLACK	PRICE (US\$) BLACK	PART # GALV.	PRICE (US\$) GALV.
1/8	25	150	13	A.BAIU			38.77
1/4	35	210	24	B.BAIU			47.21
3/8	35	210	30	C.BAIU			47.21
1/2	40	160	40	D.BAIU	*		50.24
3/4	30	60	68	E.BAIU	*		55.82
1	25	50	88	1.BAIU	*		74.49
1-1/4	15	30	149	1B.BAIU	*		102.11
1-1/2	12	24	182	1D.BAIU	*		123.24
2	8	16	260	2.BAIU	*		146.09
2-1/2	8	8	520	2D.BAIU			379.66
3	8	8	772	3.BAIU			591.67

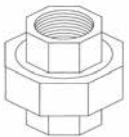

Fig. 99

MALLEABLE IRON UNIONS ALL IRON A.A.R. CLASS 300

DESCRIPTION	PCS PER BOX	PCS PER MASTER	WEIGHT PER 100	PART # BLACK	PRICE (US\$) BLACK	PART # GALV.	PRICE (US\$) GALV.
1/8	25	150	16	A.BAI300U			75.24
1/4	35	210	28	B.BAI300U			78.98
3/8	30	180	37	C.BAI300U			78.20
1/2	40	80	60	D.BAI300U			105.04
3/4	30	60	107	E.BAI300U	*		115.54
1	18	36	125	1.BAI300U	*		196.38
1-1/4	15	30	206	1B.BAI300U	*		213.91
1-1/2	10	20	253	1D.BAI300U	*		259.18
2	5	10	418	2.BAI300U			321.59
2-1/2	8	8	533	2D.BAI300U	*		627.96
3	8	8	854	3.BAI300U			1007.57

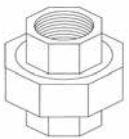

Fig. 98

MALLEABLE IRON UNIONS BRASS TO BRASS A.A.R. CLASS 300

DESCRIPTION	PCS PER BOX	PCS PER MASTER	WEIGHT PER 100	PART # BLACK	PRICE (US\$) BLACK	PART # GALV.	PRICE (US\$) GALV.
1/4	30	180	26	B.BBBU			63.01
3/8	30	180	38	C.BBBU			67.65
1/2	25	100	57	D.BBBU	*		70.12
3/4	25	50	103	E.BBBU	*		80.81
1	18	36	130	1.BBBU	*		109.13
1-1/4	15	30	208	1B.BBBU	*		143.09
1-1/2	12	24	252	1D.BBBU	*		167.26
2	5	10	417	2.BBBU	*		223.72
2-1/2	3	3	541	2D.BBBU			223.72
3	3	3	872	3.BBBU			597.85
4	1	2	1517	4.BBBU			1670.86



Fig. 95

**MALLEABLE IRON
GASKET UNIONS
CLASS 150**

DESCRIPTION	PCS PER BOX	PCS PER MASTER	WEIGHT PER 100	PART # BLACK	PRICE (US\$) BLACK	PART # GALV.	PRICE (US\$) GALV.
3/8	35	210	29	C.BGU	38.86	C.NGU	46.62
1/2	40	160	38	D.BGU	41.03	D.NGU	59.57
3/4	30	60	65	E.BGU	46.29	E.NGU	65.20
1	25	50	82	1.BGU	59.96	1.NGU	84.53
1-1/4	15	30	141	1B.BGU	82.81	1B.NGU	116.26
1-1/2	15	30	172	1D.BGU	100.63	1D.NGU	141.96
2	8	16	262	2.BGU	125.52	2.NGU	174.78



TOP BEAM CLAMPS

DESCRIPTION	PCS PER BOX	PCS PER MASTER	WEIGHT PER 100	PART # BLACK	PRICE (US\$) BLACK	PART # GALV.	PRICE (US\$) GALV.
3/8 Small Mouth	50	200	31	C.BSBC	* 4.91	C.NSBC	* 6.15
1/2 Small Mouth	100	100	46	D.BSBC	* 8.03	D.NSBC	* 10.03
3/8 Wide Mouth	100	100	52	C.BWBC	* 9.70	C.NWBC	* 12.13
1/2 Wide Mouth	100	100	50	D.BWBC	* 11.96	D.NWBC	14.95

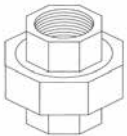

Fig. 96

**DIE ELECTRICAL
UNIONS
CLASS 150**

DESCRIPTION	PCS PER BOX	PCS PER MASTER	WEIGHT PER 100	PART # BLACK	PRICE (US\$) BLACK	PART # GALV.	PRICE (US\$) GALV.
1/2 W	40	160	40			D.NDEUW	54.64
3/4 W	30	120	38			E.NDEUW	53.44



C-CLAMPS

DESCRIPTION	PCS PER BOX	PCS PER MASTER	WEIGHT PER 100	PART # BLACK	PRICE (US\$) BLACK	PART # GALV.	PRICE (US\$) GALV.
3/8 C-Clamp	100	100	28	C.BCC	* 8.69		
1/2 C-Clamp	100	100	28	D.BCC	* 11.64		

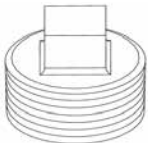
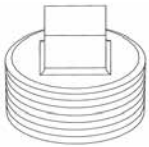

Fig. 01 & 02

**CAST IRON PLUGS
- REGULAR CORED**

DESCRIPTION	PCS PER BOX	PCS PER MASTER	WEIGHT PER 100	PART # BLACK	PRICE (US\$) BLACK	PART # GALV.	PRICE (US\$) GALV.
1/2	100	600	10	D.BP	* 3.59	D.NP	* 7.62
3/4	70	420	15	E.BP	* 4.53	E.NP	* 9.69
1	40	240	25	1.BP	* 4.53	1.NP	* 9.69
1-1/4	40	160	43	1B.BP	* 7.22	1B.NP	* 16.16
1-1/2	40	80	64	1D.BP	* 10.22	1D.NP	* 21.83
2	25	50	94	2.BP	* 11.93	2.NP	* 27.11
2-1/2	20	40	130	2D.BP	29.06	2D.NP	57.29
3	10	20	198	3.BP	* 33.66	3.NP	73.36
3-1/2	10	20	208	3D.BP	82.12	3D.NP	133.97
4 SQUARE HEAD	5	10	409	4.BPSH	69.96	4.NPSH	201.32
4 BAR HEAD	5	10	399	4.BP	* 69.33	4.NP	142.28
5 BAR HEAD	5	5	627	5.BP	130.32	5.NP	282.87
6 BAR HEAD	4	4	970	6.BP	170.13	6.NP	321.79



**CAST IRON PLUGS
- SOLID**

Fig. 03 & 04

DESCRIPTION	PCS PER BOX	PCS PER MASTER	WEIGHT PER 100	PART # BLACK	PRICE (US\$) BLACK	PART # GALV.	PRICE (US\$) GALV.
1/2	100	600	10	D.BSP	*	4.01	D.NSP
3/4	50	300	17	E.BSP	*	12.11	E.NSP
1	30	180	33	1.BSP	*	12.90	1.NSP
1-1/4	30	120	57	1B.BSP	*	14.85	1B.NSP
1-1/2	40	80	80	1D.BSP	*	21.05	1D.NSP
2	25	50	125	2.BSP		27.17	2.NSP
2-1/2	10	20	195	2D.BSP		40.21	2D.NSP
3	10	20	350	3.BSP		68.60	3.NSP
4 BAR HEAD	5	10	576	4.BSP		152.56	4.NSP
5 BAR HEAD	5	5	970	5.BSP		283.55	



**CAST IRON
COUNTERSUNK
PLUGS**

Fig. 05

DESCRIPTION	PCS PER BOX	PCS PER MASTER	WEIGHT PER 100	PART # BLACK	PRICE (US\$) BLACK	PART # GALV.	PRICE (US\$) GALV.
1/2 MI	100	600	6	D.BCTP		8.21	D.NCTP
3/4 MI	80	480	10	E.BCTP		11.16	E.NCTP
1 MI	40	240	22	1.BCTP		15.63	1.NCTP
1-1/4	40	160	35	1B.BCTP		16.34	1B.NCTP
1-1/2	50	100	48	1D.BCTP		19.56	1D.NCTP
2	40	80	84	2.BCTP		28.86	2.NCTP
2-1/2	20	40	150	2D.BCTP		45.62	2D.NCTP
3	10	20	225	3.BCTP		74.51	3.NCTP
4	5	5	390	4.BCTP		200.81	4.NCTP



**HEX HEAD
CLEANOUT
PLUGS**

Fig. 06

DESCRIPTION	PCS PER BOX	PCS PER MASTER	WEIGHT PER 100	PART # BLACK	PRICE (US\$) BLACK	PART # GALV.	PRICE (US\$) GALV.
1-1/4	1	1	28	1B.BCOP		8.97	1B.NCOP
4	1	1	172	4.BCOP		56.61	4.NCOP

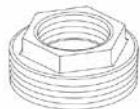

**HEXAGON
BUSHINGS**

DESCRIPTION	PCS PER BOX	PCS PER MASTER	WEIGHT PER 100	PART # BLACK	PRICE (US\$) BLACK	PART # GALV.	PRICE (US\$) GALV.
3/8x1/4	25	150	3	CXB.BMB	*	9.10	CXB.NMB
1/2x3/8	25	150	6	DXC.BMB	*	9.10	DXC.NMB
1/2x1/4	25	150	7	DXB.BMB	*	9.10	DXB.NMB
1/2x1/8	25	150	8	DXA.BMB	*	9.10	DXA.NMB
3/4 x 1/2	25	150	10	EXD.BB	*	7.88	EXD.NB
3/4 x 3/8	25	150	11	EXC.BB	*	8.76	EXC.NB
3/4 x 1/4	25	150	12	EXB.BB	*	8.53	EXB.NB
3/4 x 1/8	25	150	15	EXA.BB	*	8.99	EXA.NB
1 x 3/4	25	150	17	1XE.BB	*	8.28	1XE.NB
1 x 1/2	25	150	21	1XD.BB	*	8.40	1XD.NB
1 x 3/8	25	150	18	1XC.BB	*	11.35	1XC.NB
1 x 1/4	25	150	25	1XB.BB	*	11.04	1XB.NB
1 x 1/8	25	150	21	1XA.BB	*	12.79	1XA.NB
1-1/4 x 1	25	150	30	1BX1.BB	*	10.80	1BX1.NB
1-1/4 x 3/4	25	150	38	1BXE.BB	*	10.80	1BXE.NB
1-1/4 x 1/2	25	150	31	1BXD.BB	*	12.29	1BXD.NB
1-1/4 x 3/8	25	150	34	1BXC.BB	*	13.29	1BXC.NB
1-1/4 x 1/4	25	150	36	1BXB.BB	*	15.87	1BXB.NB
1-1/4 x 1/8	25	150	36	1BXA.BB		15.39	1BXA.NB
1-1/2 x 1-1/4	30	120	31	1DX1B.BB	*	13.72	1DX1B.NB
1-1/2 x 1	30	120	47	1DX1.BB	*	12.34	1DX1.NB
1-1/2 x 3/4	30	120	43	1DXE.BB	*	14.06	1DXE.NB
1-1/2 x 1/2	30	120	40	1DXD.BB	*	14.06	1DXD.NB
1-1/2 x 3/8	30	120	47	1DXC.BB	*	20.97	1DXC.NB
1-1/2 x 1/4	15	90	49	1DXB.BB	*	18.49	1DXB.NB
1-1/2 x 1/8	30	120	62	1DXA.BB		17.27	1DXA.NB
2 x 1-1/2	20	80	61	2X1D.BB	*	17.27	2X1D.NB
2 x 1-1/4	20	80	85	2X1B.BB	*	16.88	2X1B.NB

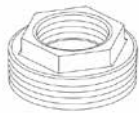
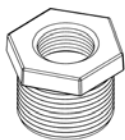

Fig. 09

HEXAGON BUSHINGS
(continued)

DESCRIPTION	PCS PER BOX	PCS PER MASTER	WEIGHT PER 100	PART # BLACK	PRICE (US\$) BLACK	PART # GALV.	PRICE (US\$) GALV.		
2 x 1	20	80	75	2X1.BB	*	16.88	2X1.NB	*	33.00
2 x 3/4	20	80	61	2XE.BB	*	17.66	2XE.NB	*	33.00
2 x 1/2	20	80	60	2XD.BB	*	22.33	2XD.NB	*	35.50
2 x 3/8	20	80	71	2XC.BB	*	25.11	2XC.NB		42.24
2 x 1/4	20	80	73	2XB.BB	*	19.94	2XB.NB		41.27
2-1/2 x 2	20	20	113	2DX2.BB	*	26.61	2DX2.NB		47.37
2-1/2 x 1-1/2	20	20	111	2DX1D.BB		27.02	2DX1D.NB		54.10
2-1/2 x 1-1/4	20	20	105	2DX1B.BB		31.05	2DX1B.NB		60.10
2-1/2 x 1	20	20	90	2DX1.BB		31.05	2DX1.NB		60.10
2-1/2 x 3/4	20	20	120	2DXE.BB		31.05	2DXE.NB		60.10
2-1/2 x 1/2	20	20	102	2DXD.BB		28.95	2DXD.NB		60.10
3 x 2-1/2	10	10	161	3X2D.BB		36.34	3X2D.NB		66.18
3 x 2	10	20	164	3X2.BB		31.35	3X2.NB		61.65
3 x 1-1/2	10	20	157	3X1D.BB		41.98	3X1D.NB		71.35
3 x 1-1/4	10	20	152	3X1B.BB		41.98	3X1B.NB		77.44
3 x 1	10	20	168	3X1.BB		41.98	3X1.NB		79.28
3 x 3/4	10	20	190	3XE.BB		45.62	3XE.NB		79.28
3 x 1/2	10	20	155	3XD.BB		46.74	3XD.NB		79.28
3 x 1/4	10	20	197	3XB.BB		38.38	3XB.NB		73.54
3-1/2 x 3	10	10	247	3DX3.BB		73.59	3DX3.NB		140.79
3-1/2 x 2-1/2	10	10	198	3DX2D.BB		81.74	3DX2D.NB		140.79
3-1/2 x 2	10	10	190	3DX2.BB		79.82	3DX2.NB		140.79
3-1/2 x 1-1/2	10	10	234	3DX1D.BB		81.74	3DX1D.NB		140.79
3-1/2 x 1-1/4	10	10	212	3DX1B.BB		81.74	3DX1B.NB		128.50
3-1/2 x 1	10	10	219	3DX1.BB		81.74	3DX1.NB		128.50
3-1/2 x 3/4	10	10	228	3DXE.BB		81.74			
4 x 3-1/2	10	10	200	4X3D.BB		95.14	4X3D.NB		166.15
4 x 3	10	10	318	4X3.BB		70.71	4X3.NB		129.44
4 x 2-1/2	10	10	280	4X2D.BB		85.57	4X2D.NB		166.15
4 x 2	10	10	270	4X2.BB		70.71	4X2.NB		129.44
4 x 1-1/2	10	10	286	4X1D.BB		87.61	4X1D.NB		166.15
4 x 1-1/4	10	10	250	4X1B.BB		95.14	4X1B.NB		166.15
4 x 1	10	10	273	4X1.BB		95.14	4X1.NB		166.15
4 x 1/2	10	10	291	4XD.BB		87.33	4XD.NB		154.21
5 x 4	10	10	474	5X4.BB		144.00	5X4.NB		274.33
5 x 3	10	10	496	5X3.BB		148.27	5X3.NB		280.90
5 x 2-1/2	10	10	543	5X2D.BB		164.80	5X2D.NB		256.40
5 x 2	10	10	445	5X2.BB		164.80	5X2.NB		280.90
6 x 5	6	6	617	6X5.BB		169.98	6X5.NB		317.78
6 x 4	6	6	788	6X4.BB		147.18	6X4.NB		299.79
6 x 3	6	6	752	6X3.BB		170.01	6X3.NB		317.78
6 x 2-1/2	6	6	620	6X2D.BB		188.95	6X2D.NB		319.77
6 x 2	6	6	650	6X2.BB		170.01	6X2.NB		317.78
8 x 6	2	2	1112	8X6.BB		320.34	8X6.NB		553.97
8 x 4	2	2	1828	8X4.BB		355.85	8X4.NB		596.61



**TANK BUSHINGS,
DOUBLE TAPPED
HVY TYPE ONLY**

DESCRIPTION	PCS PER BOX	PCS PER MASTER	WEIGHT PER 100	PART # BLACK	PRICE (US\$) BLACK	PART # GALV.	PRICE (US\$) GALV.
1 x 1/2 x 1/2	50	50	37	1XD.BTB	17.77	1XD.NTB	29.68
1-1/2 x 1 x 1	40	40	66	1DX1.BTB	25.87	1DX1.NTB	43.16
2 x 1-1/2 x 1-1/2	20	20	89	2X1D.BTB	34.90	2X1D.NTB	58.16
2 x 1-1/4 x 1-1/4	20	20	120	2X1B.BTB	34.90	2X1B.NTB	58.16
2 x 1 x 1	20	20	136	2X1.BTB	34.90	2X1.NTB	58.16
2 x 3/4 x 3/4	20	20	155	2XE.BTB	34.90	2XE.NTB	58.16
2 x 1/2 x 1/2	20	20	165	2XD.BTB	34.90	2XD.NTB	58.16
2 x 3/8 x 3/8	20	20	174	2XC.BTB	34.90	2XC.NTB	47.77
3 x 2 x 2	10	10	350	3X2.BTB	70.73	3X2.NTB	115.33
3 x 1 x 1	10	10	525	3X1.BTB	70.73	3X1.NTB	115.33
4 x 3 x 3	5	5	425	4X3.BTB	138.79	4X3.NTB	231.43
4 x 2-1/2 x 2-1/2	5	5	601	4X2D.BTB	127.95	4X2D.NTB	213.49
4 x 2 x 2	5	5	349	4X2.BTB	127.95	4X2.NTB	213.49
4 x 1-1/2 x 1-1/2	5	5	334	4X1D.BTB	127.95	4X1D.NTB	213.49
4 x 1 x 1	5	5	650	4X1.BTB	127.95	4X1.NTB	213.49



Fig. 10

FLUSH BUSHINGS

DESCRIPTION	PCS PER BOX	PCS PER MASTER	WEIGHT PER 100	PART # BLACK	PRICE (US\$) BLACK	PART # GALV.	PRICE (US\$) GALV.		
1 x 3/4	25	150	12	1XE.BFB	*	21.85	1XE.NFB	*	36.83
1 x 1/2	25	150	14	1XD.BFB	*	17.59	1XD.NFB	*	36.83
1-1/4 x 1	25	150	20	1BX1.BFB	*	23.64	1BX1.NFB	*	45.59
1-1/4 x 3/4	25	150	27	1BXE.BFB		17.81	1BXE.NFB		48.15
1-1/4 x 1/2	25	150	30	1BXD.BFB		18.34	1BXD.NFB		48.15
1-1/2 x 1-1/4	30	120	20	1DX1B.BFB	*	29.49	1DX1B.NFB	*	65.34
1-1/2 x 1	30	120	32	1DX1.BFB	*	28.33	1DX1.NFB	*	64.57
1-1/2 x 3/4	30	120	40	1DXE.BFB		32.71	1DXE.NFB		66.68
1-1/2 x 1/2	30	120	45	1DXD.BFB		32.71	1DXD.NFB		66.50
2 x 1-1/2	20	80	42	2X1D.BFB	*	39.71	2X1D.NFB	*	86.07
2 x 1-1/4	20	80	54	2X1B.BFB		38.16	2X1B.NFB		82.78
2 x 1	20	80	62	2X1.BFB	*	38.16	2X1.NFB	*	82.78
2 x 3/4	20	80	70	2XE.BFB		37.15	2XE.NFB		80.63
2 x 1/2	20	80	66	2XD.BFB		43.09	2XD.NFB		91.38
2-1/2 x 2	20	20	56	2DX2.BFB		56.18	2DX2.NFB		114.82
2-1/2 x 1-1/4	20	20	100	2DX1B.BFB		41.38	2DX1B.NFB		102.38
3 x 2-1/2	10	10	95	3X2D.BFB		82.67	3X2D.NFB		173.13
3 x 2	10	10	134	3X2.BFB		92.55	3X2.NFB		155.01
3 x 1-1/2	10	10	95	3X1D.BFB		90.98	3X1D.NFB		137.52
3 x 1-1/4	10	10	95	3X1B.BFB		86.76			
3-1/2 x 2-1/2	10	10	171	3DX2D.BFB		124.86	3DX2D.NFB		238.35
4 x 3-1/2	10	10	115	4X3D.BFB		179.23	4X3D.NFB		317.23
4 x 3	10	10	200	4X3.BFB		176.10	4X3.NFB		332.45
4 x 2-1/2	10	10	252	4X2D.BFB		160.72	4X2D.NFB		332.45
4 x 2	10	10	280	4X2.BFB		212.64	4X2.NFB		330.05
5 x 4	10	10	300	5X4.BFB		212.64	5X4.NFB		330.05
6 x 5	6	6	375	6X5.BFB		326.60	6X5.NFB		595.63
6 x 4	6	6	550	6X4.BFB		339.68	6X4.NFB		655.38
8 x 6	2	2	925	8X6.BFB		880.95	8X6.NFB		1818.77



Fig. 21

**CAST IRON
90° ELBOWS
CLASS 125**

DESCRIPTION	PCS PER BOX	PCS PER MASTER	WEIGHT PER 100	PART # BLACK	PRICE (US\$) BLACK	PART # GALV.	PRICE (US\$) GALV.		
1/4	25	150	17	B.BCL	*	14.23	B.NCL		23.84
3/8	25	150	25	C.BCL	*	20.60	C.NCL		23.84
1/2	100	100	41	D.BCL	*	9.02	D.NCL		27.17
3/4	100	100	69	E.BCL	*	9.40	E.NCL		26.67
1	50	50	104	1.BCL	*	11.13	1.NCL		30.82
1-1/4	25	25	158	1B.BCL	*	15.80	1B.NCL		47.97
1-1/2	25	25	209	1D.BCL	*	21.85	1D.NCL		65.88
2	15	15	339	2.BCL	*	34.15	2.NCL		97.28
2-1/2	10	10	514	2D.BCL	*	81.82	2D.NCL		199.64
3	6	6	787	3.BCL		133.99	3.NCL		303.67
3-1/2	3	3	955	3D.BCL		363.93	3D.NCL		484.77
4	2	2	1323	4.BCL		248.41	4.NCL		556.38
5	1	1	2040	5.BCL		544.21			
6	1	1	2985	6.BCL		705.20			
8	1	1	6456	8.BCL		1724.44			
3/4 x 1/2	100	100	56	EXD.BCL	*	18.97	EXD.NCL		30.85
1/2 x 1/4	1	1	40	DXB.BCL		22.23			
1/2 x 3/8	100	100	34	DXC.BCL		28.67			
1 x 1/2	50	50	71	1XD.BCL	*	14.06	1XD.NCL		33.83
1 x 3/4	50	50	92	1XE.BCL	*	15.84	1XE.NCL		35.74
1-1/4 x 1	25	25	127	1BX1.BCL	*	19.94	1BX1.NCL		52.43
1-1/4 x 3/4	25	25	115	1BXE.BCL	*	22.73	1BXE.NCL		45.64
1-1/4 x 1/2	25	25	100	1BXD.BCL	*	22.36	1BXD.NCL		55.47
1-1/2 x 1-1/4	25	25	190	1DX1B.BCL	*	40.27	1DX1B.NCL		78.37
1-1/2 x 1	25	25	157	1DX1.BCL	*	36.81	1DX1.NCL		76.81
1-1/2 x 3/4	25	25	146	1DXE.BCL	*	36.81	1DXE.NCL		66.85
1-1/2 x 1/2	25	25	147	1DXD.BCL	*	39.49	1DXD.NCL		81.40
2 x 1-1/2	15	15	274	2X1D.BCL	*	53.88	2X1D.NCL		94.64
2 x 1-1/4	15	15	249	2X1B.BCL	*	57.62	2X1B.NCL		115.26
2 x 1	15	15	227	2X1.BCL	*	53.88	2X1.NCL		115.26



Fig. 21

**CAST IRON
90° ELBOWS
CLASS 125
(continued)**

DESCRIPTION	PCS PER BOX	PCS PER MASTER	WEIGHT PER 100	PART # BLACK	PRICE (US\$) BLACK	PART # GALV.	PRICE (US\$) GALV.	
2 x 3/4	15	15	206	2XE.BCL	*	53.88	2XE.NCL	115.26
2 x 1/2	15	15	204	2XD.BCL	*	61.39	2XD.NCL	115.26
2-1/2 x 2	10	10	400	2DX2.BCL		108.82	2DX2.NCL	208.45
2-1/2 x 1-1/2	10	10	326	2DX1D.BCL		122.71	2DX1D.NCL	208.45
4 x 3	4	4	1067	4X3.BCL		350.53	4X3.NCL	581.34
4 x 2-1/2	4	4	890	4X2D.BCL		350.53	4X2D.NCL	616.22
4 x 2	4	4	775	4X2.BCL		350.53	4X2.NCL	581.34
4 x 1-1/2	4	4	850	4X1D.BCL		343.21	4X1D.NCL	616.22
2-1/2 x 1-1/4	10	10	326	2DX1B.BCL		125.67	2DX1B.NCL	220.96
2-1/2 x 1	10	10	258	2DX1.BCL		125.67	2DX1.NCL	220.96
2-1/2 x 3/4	10	10	280	2DXE.BCL		123.00	2DXE.NCL	220.96
3 x 2-1/2	6	6	574	3X2D.BCL		205.44	3X2D.NCL	357.04
3 x 2	6	6	575	3X2.BCL		189.26	3X2.NCL	336.82
3 x 1-1/2	6	6	603	3X1D.BCL		205.44	3X1D.NCL	357.04
3 x 1-1/4	6	6	465	3X1B.BCL		205.44	3X1B.NCL	293.17
3 x 1	6	6	475	3X1.BCL		201.20	3X1.NCL	505.98
5 x 4	1	1	1690	5X4.BCL		806.69		
6 x 3	1	1	2038	6X3.BCL		1068.23		
6 x 4	1	1	2465	6X4.BCL		1068.23		



Fig. 23

**CAST IRON
45° ELBOWS
CLASS 125**

DESCRIPTION	PCS PER BOX	PCS PER MASTER	WEIGHT PER 100	PART # BLACK	PRICE (US\$) BLACK	PART # GALV.	PRICE (US\$) GALV.	
1/4	1	1	16	B.BC45L				
3/8	1	1	25	C.BC45L				
1/2	100	100	36	D.BC45L	*	13.80	D.NC45L	27.15
3/4	100	100	60	E.BC45L	*	13.89	E.NC45L	31.14
1	50	50	87	1.BC45L	*	16.29	1.NC45L	38.29
1-1/4	25	25	140	1B.BC45L	*	21.90	1B.NC45L	57.16
1-1/2	25	25	180	1D.BC45L	*	36.29	1D.NC45L	80.81
2	15	15	298	2.BC45L	*	41.86	2.NC45L	113.32
2-1/2	10	10	462	2D.BC45L		108.85	2D.NC45L	182.68
3	6	6	655	3.BC45L		172.40	3.NC45L	356.34
4	2	2	992	4.BC45L		358.44	4.NC45L	653.37
6	1	1	2530	6.BC45L		1037.31		556.38



Fig. 24

**CAST IRON
STRAIGHT TEES
CLASS 125**

DESCRIPTION	PCS PER BOX	PCS PER MASTER	WEIGHT PER 100	PART # BLACK	PRICE (US\$) BLACK	PART # GALV.	PRICE (US\$) GALV.	
1/4	1	1	22	B.BCT			25.01	
3/8	25	150	38	C.BCT	*	21.64	C.NCT	28.73
1/2	100	100	55	D.BCT	*	14.06	D.NCT	27.73
3/4	50	50	92	E.BCT	*	16.40	E.NCT	38.36
1	25	25	142	1.BCT	*	14.59	1.NCT	41.65
1-1/4	25	25	223	1B.BCT	*	26.64	1B.NCT	72.87
1-1/2	25	25	287	1D.BCT	*	34.61	1D.NCT	96.39
2	15	15	469	2.BCT	*	48.19	2.NCT	120.26
2-1/2	9	9	675	2D.BCT		125.21	2D.NCT	244.46
3	5	5	994	3.BCT		192.15	3.NCT	550.27
3-1/2	3	3	1246	3D.BCT		387.54	3D.NCT	688.02
4	2	2	1737	4.BCT		374.80	4.NCT	770.96
5	1	1	2718	5.BCT		1025.07		
6	1	1	3960	6.BCT		1163.78		



Fig. 25

**CAST IRON
REDUCING TEES
CLASS 125**

DESCRIPTION	PCS PER BOX	PCS PER MASTER	WEIGHT PER 100	PART # BLACK	PRICE (US\$) BLACK	PART # GALV.	PRICE (US\$) GALV.
1/2 x 1/2 x 1/4	1	1	60	DXB.BCT			34.69
1/2 x 1/2 x 3/8	25	25	55	DXC.BCT			41.28
1/2 x 1/2 x 3/4	50	50	99	DXE.BCT	*		43.90
1/2 x 1/2 x 1	45	45	88	DX1.BCT	*		
3/4 x 3/4 x 1/4	1	1	62	EXB.BCT			30.11
3/4 x 3/4 x 1/2	50	50	81	EXD.BCT	*		41.43
3/4 x 3/4 x 3/8	50	50	81	EXC.BCT			43.90
3/4x1/2x3/4	50	50	96	EXDXE.BCT	*		41.43
3/4x1/2x1/2	50	50	66	EXDXD.BCT	*		41.43
3/4 x 3/4 x 1	45	45	135	EX1.BCT	*		54.11
1 x 1 x 3/4	50	50	126	1XE.BCT	*		48.71
1 x 1 x 1/2	50	50	108	1XD.BCT	*		50.33
1 x 1 x 3/8	50	50	116	1XC.BCT			50.33
1 x 3/4 x 1	50	50	126	1XEX1.BCT	*		40.00
1 x 3/4 x 3/4	50	50	100	1XEXE.BCT	*		46.88
1 x 3/4 x 1/2	50	50	97	1XEXD.BCT			49.69
1 x 1/2 x 1	50	50	109	1XDX1.BCT	*		46.13
1 x 1/2 x 3/4	50	50	100	1XDXE.BCT			49.69
1 x 1/2 x 1/2	50	50	84	1XDXD.BCT			44.43
1 x 1 x 1/4	1	1	85	1XB.BCT			
1 x 1/4 x 1	50	50	106	1XB1.BCT			54.11
1 x 1 x 2	1	1	225	1X2.BCT			99.77
1 x 1 x 1-1/4	25	25	164	1X1B.BCT	*		80.15
1 x 1 x 1-1/2	25	25	184	1X1D.BCT			69.51
1 x 1/2 x 1-1/4	25	25	187	1XDX1B.BCT			81.74
1 x 3/4 x 1-1/4	25	25	202	1XEX1B.BCT			81.74
1-1/4 x 1/2 x 1-1/4	25	25	181	1BXDX1B.BCT	*		77.11
1-1/4 x 1/2 x 1-1/2	25	25	230	1BXDX1D.BCT			111.02
1-1/4 x 1/2 x 1	25	25	185	1BXDX1.BCT	*		77.11
1-1/4 x 1/2 x 3/4	25	25	144	1BXDXE.BCT			81.74
1-1/4 x 1/2 x 1/2	25	25	110	1BXDXD.BCT			81.74
1-1/4 x 3/4 x 1-1/2	25	25	230	1BXEX1D.BCT			118.29
1-1/4 x 3/4 x 1-1/4	25	25	177	1BXEX1B.BCT	*		71.47
1-1/4 x 3/4 x 1	25	25	172	1BXEX1.BCT	*		81.74
1-1/4 x 3/4 x 3/4	25	25	136	1BXEXE.BCT	*		81.74
1-1/4 x 3/4 x 1/2	25	25	150	1BXEXD.BCT			81.74
1-1/4 x 1-1/4 x 1-1/2	25	25	278	1BX1D.BCT	*		113.88
1-1/4 x 1-1/4 x 1	25	25	185	1BX1.BCT	*		75.74
1-1/4 x 1-1/4 x 3/4	25	25	165	1BXE.BCT	*		62.20
1-1/4 x 1-1/4 x 1/2	25	25	164	1BXD.BCT	*		75.74
1-1/4 x 1 x 1	25	25	164	1BX1X1.BCT	*		75.74
1-1/4 x 1 x 1-1/4	25	25	195	1BX1X1B.BCT	*		80.15
1-1/4 x 1 x 1-1/2	25	25	270	1BX1X1D.BCT	*		113.88
1-1/4 x 1 x 2	1	1	267	1BX1X2.BCT			
1-1/4 x 1 x 3/4	25	25	160	1BX1XE.BCT	*		80.15
1-1/4 x 1 x 1/2	25	25	136	1BX1XD.BCT	*		75.74
1-1/4 x 1-1/4 x 2	1	1	290	1BX2.BCT			
1-1/2 x 3/4 x 1/2	25	25	171	1DXEXD.BCT			114.46
1-1/2 x 3/4 x 3/4	25	25	166	1DXEXE.BCT			114.46
1-1/2 x 3/4 x 1	25	25	192	1DXEX1.BCT			93.98
1-1/2 x 3/4 x 1-1/4	25	25	230	1DXEX1B.BCT	*		114.46
1-1/2 x 3/4 x 1-1/2	25	25	228	1DXEX1D.BCT	*		91.16
1-1/2 x 1/2 x 1-1/4	25	25	235	1DXDX1B.BCT	*		111.02
1-1/2 x 1/2 x 1-1/2	25	25	217	1DXDX1D.BCT	*		111.02
1-1/2 x 1/2 x 1/2	25	25	158	1DXDXD.BCT			110.80
1-1/2 x 1/2 x 3/4	25	25	167	1DXDXE.BCT			110.80
1-1/2 x 1 x 1/2	25	25	191	1DX1XD.BCT	*		111.02
1-1/2 x 1 x 3/4	25	25	192	1DX1XE.BCT	*		111.02
1-1/2 x 1 x 1	25	25	189	1DX1X1.BCT	*		93.51
1-1/2 x 1 x 1-1/4	25	25	271	1DX1X1B.BCT	*		111.02
1-1/2 x 1 x 1-1/2	25	25	253	1DX1X1D.BCT	*		108.95
1-1/2 x 1 x 2	15	15	411	1DX1X2.BCT	*		151.65
1-1/2 x 1-1/4 x 1/2	25	25	178	1DX1BXD.BCT	*		103.02
1-1/2 x 1-1/4 x 3/4	25	25	204	1DX1BXE.BCT	*		108.95
1-1/2 x 1-1/4 x 1	25	25	218	1DX1BX1.BCT	*		103.02
1-1/2 x 1-1/4 x 1-1/4	25	25	236	1DX1BX1B.BCT	*		113.88



Fig. 25

**CAST IRON
REDUCING TEES
CLASS 125
(continued)**

DESCRIPTION	PCS PER BOX	PCS PER MASTER	WEIGHT PER 100	PART # BLACK		PRICE (US\$) BLACK	PART # GALV.	PRICE (US\$) GALV.
1-1/2 x 1-1/4 x 1-1/2	25	25	271	1DX1BX1D.BCT	*	48.80	1DX1BX1D.NCT	113.88
1-1/2 x 1-1/4 x 2	15	15	430	1DX1BX2.BCT	*	74.69	1DX1BX2.NCT	148.80
1-1/2 x 1-1/2 x 1-1/2	25	25	200	1DXD.BCT	*	34.31	1DXD.NCT	103.02
1-1/2 x 1-1/2 x 3/4	25	25	217	1DXE.BCT	*	37.06	1DXE.NCT	103.02
1-1/2 x 1-1/2 x 1	25	25	228	1DXI.BCT	*	34.31	1DXI.NCT	103.02
1-1/2 x 1-1/2 x 1-1/4	25	25	262	1DX1B.BCT	*	48.80	1DX1B.NCT	113.88
1-1/2 x 1-1/2 x 2	15	15	355	1DX2.BCT	*	53.37	1DX2.NCT	148.80
1-1/2 x 1-1/2 x 2-1/2	10	10	425	1DX2D.BCT	*	164.63	1DX2D.NCT	288.47
2 x 2 x 1-1/2	15	15	396	2X1D.BCT	*	57.72	2X1D.NCT	148.80
2 x 2 x 1-1/4	15	15	364	2X1B.BCT	*	54.61	2X1B.NCT	140.68
2 x 2 x 1	15	15	326	2X1.BCT	*	48.63	2X1.NCT	140.68
2 x 2 x 3/4	15	15	310	2XE.BCT	*	48.63	2XE.NCT	140.68
2 x 2 x 1/2	15	15	290	2XD.BCT	*	48.63	2XD.NCT	140.68
2 x 1-1/2 x 2	15	15	400	2X1DX2.BCT	*	66.31	2X1DX2.NCT	120.10
2 x 1-1/2 x 1-1/2	15	15	346	2X1DX1D.BCT	*	74.69	2X1DX1D.NCT	146.26
2 x 1-1/2 x 1-1/4	15	15	363	2X1DX1B.BCT	*	76.16	2X1DX1B.NCT	125.10
2 x 1-1/2 x 1	15	15	289	2X1DX1.BCT	*	48.63	2X1DX1.NCT	140.68
2 x 1-1/2 x 3/4	15	15	273	2X1DXE.BCT	*	55.66	2X1DXE.NCT	140.68
2 x 1-1/2 x 1/2	15	15	239	2X1DXD.BCT	*	55.66	2X1DXD.NCT	140.68
2 x 1-1/4 x 2	15	15	396	2X1BX2.BCT	*	66.31	2X1BX2.NCT	126.40
2 x 1-1/4 x 1-1/2	15	15	363	2X1BX1D.BCT	*	87.74	2X1BX1D.NCT	151.65
2 x 1-1/4 x 1-1/4	15	15	300	2X1BX1B.BCT	*	76.23	2X1BX1B.NCT	124.52
2 x 1-1/4 x 1	15	15	310	2X1BX1.BCT	*	85.66	2X1BX1.NCT	151.65
2 x 1-1/4 x 1/2	15	15	244	2X1BXD.BCT	*	87.74	2X1BXD.NCT	143.06
2 x 1-1/4 x 3/4	1	1	250	2X1BXE.BCT		99.77		
2 x 1 x 2	15	15	370	2X1X2.BCT	*	76.84	2X1X2.NCT	140.68
2 x 1 x 1-1/2	15	15	413	2X1X1D.BCT	*	71.27	2X1X1D.NCT	151.65
2 x 1 x 1-1/4	15	15	300	2X1X1B.BCT	*	87.74	2X1X1B.NCT	151.65
2 x 1 x 1	15	15	240	2X1X1.BCT	*	85.66	2X1X1.NCT	143.06
2 x 1 x 3/4	15	15	250	2X1XE.BCT	*	85.67	2X1XE.NCT	151.65
2 x 3/4 x 2	15	15	380	2XEX2.BCT	*	69.65	2XEX2.NCT	148.33
2 x 3/4 x 1-1/2	15	15	410	2XEX1D.BCT	*	87.74	2XEX1D.NCT	143.06
2 x 3/4 x 1-1/4	15	15	424	2XEX1B.BCT	*	87.74	2XEX1B.NCT	151.65
2 x 3/4 x 1	15	15	250	2XEX1.BCT	*	87.74	2XEX1.NCT	151.65
2 x 1/2 x 2	15	15	330	2XDX2.BCT	*	76.23	2XDX2.NCT	143.06
2 x 1/2 x 1-1/2	15	15	314	2XDX1D.BCT	*	87.74	2XDX1D.NCT	151.65
2 x 1/2 x 1-1/4	15	15	341	2XDX1B.BCT	*	87.74	2XDX1B.NCT	143.06
2 x 1/2 x 1/2	15	15	220	2XDXD.BCT	*	87.74		
2-1/2 x 2-1/2 x 3	6	6	958	2DX3.BCT	*	247.41	2DX3.NCT	456.70
2-1/2 x 2 x 3	6	6	888	2DX2X3.BCT	*	247.41	2DX2X3.NCT	357.05
2-1/2 x 2-1/2 x 2	10	10	610	2DX2.BCT	*	141.98	2DX2.NCT	272.13
2-1/2 x 2-1/2 x 1-1/2	10	10	500	2DX1D.BCT	*	145.35	2DX1D.NCT	288.47
2-1/2 x 2-1/2 x 1-1/4	10	10	450	2DX1B.BCT	*	141.98	2DX1B.NCT	272.13
2-1/2 x 2-1/2 x 1	10	10	469	2DX1.BCT	*	139.22	2DX1.NCT	267.00
2-1/2 x 2-1/2 x 3/4	10	10	475	2DXE.BCT	*	141.98	2DXE.NCT	272.13
2-1/2 x 2-1/2 x 1/2	10	10	490	2DXD.BCT	*	157.81	2DXD.NCT	288.47
2-1/2 x 2 x 2-1/2	10	10	575	2DX2X2D.BCT	*	142.61	2DX2X2D.NCT	283.01
2-1/2 x 2 x 2	10	10	537	2DX2X2.BCT	*	145.35	2DX2X2.NCT	272.13
2-1/2 x 2 x 1-1/2	10	10	574	2DX2X1D.BCT	*	157.81	2DX2X1D.NCT	236.85
2-1/2 x 2 x 1-1/4	10	10	412	2DX2X1B.BCT	*	164.63	2DX2X1B.NCT	272.13
2-1/2 x 2 x 1	10	10	440	2DX2X1.BCT	*	141.98	2DX2X1.NCT	288.47
2-1/2 x 2 x 3/4	10	10	433	2DX2XE.BCT	*	139.22	2DX2XE.NCT	232.37
2-1/2 x 2 x 1/2	10	10	350	2DX2XD.BCT	*	164.63	2DX2XD.NCT	288.47
2-1/2 x 1-1/2 x 2-1/2	10	10	535	2DX1DX2D.BCT	*	164.63	2DX1DX2D.NCT	288.47
2-1/2 x 1-1/2 x 2	10	10	558	2DX1DX2.BCT	*	164.63	2DX1DX2.NCT	288.47
2-1/2 x 1-1/2 x 1-1/2	10	10	601	2DX1DX1D.BCT	*	164.63	2DX1DX1D.NCT	236.85
2-1/2 x 1-1/2 x 1-1/4	10	10	446	2DX1DX1B.BCT	*	164.61	2DX1DX1B.NCT	301.37
2-1/2 x 1-1/2 x 1/2	10	10	376	2DX1DXD.BCT	*	155.30	2DX1DXD.NCT	301.37
2-1/2 x 1-1/4 x 2-1/2	10	10	520	2DX1BX2D.BCT	*	164.63	2DX1BX2D.NCT	232.37
2-1/2 x 1-1/4 x 2	10	10	557	2DX1BX2.BCT	*	164.63	2DX1BX2.NCT	232.37
2-1/2 x 1-1/4 x 1-1/4	10	10	380	2DX1BX1B.BCT	*	164.61	2DX1BX1B.NCT	301.37
2-1/2 x 1-1/4 x 1	10	10	394	2DX1BX1.BCT	*	164.61	2DX1BX1.NCT	301.37
2-1/2 x 1 x 2-1/2	10	10	525	2DX1X2D.BCT	*	145.35	2DX1X2D.NCT	283.01
2-1/2 x 1 x 2	10	10	470	2DX1X2.BCT	*	164.63	2DX1X2.NCT	283.01
2-1/2 x 1 x 1-1/4	10	10	388	2DX1X1B.BCT	*	164.61	2DX1X1B.NCT	283.01
2-1/2 x 1 x 1	10	10	315	2DX1X1.BCT	*	164.61		
2-1/2 x 1 x 3/4	10	10	280	2DX1XE.BCT	*	164.61		



Fig. 25

**CAST IRON
REDUCING TEES
CLASS 125
(continued)**

DESCRIPTION	PCS PER BOX	PCS PER MASTER	WEIGHT PER 100	PART # BLACK	PRICE (US\$) BLACK	PART # GALV.	PRICE (US\$) GALV.
2-1/2 x 3/4 x 2-1/2	10	10	532	2DXEX2D.BCT	145.24	2DXEX2D.NCT	278.03
2-1/2 x 3/4 x 2	10	10	440	2DXEX2.BCT	145.24	2DXEX2.NCT	283.01
2-1/2 x 1/2 x 2-1/2	10	10	549	2DXDX2D.BCT	148.64	2DXDX2D.NCT	278.03
2 x 2 x 3	6	6	922	2X3.BCT	223.24	2X3.NCT	434.85
2 x 2 x 2-1/2	10	10	550	2X2D.BCT	123.80	2X2D.NCT	230.34
2 x 1-1/2 x 2-1/2	10	10	628	2X1DX2D.BCT	142.10	2X1DX2D.NCT	288.47
2 x 1-1/4 x 2-1/2	10	10	556	2X1BX2D.BCT	164.63	2X1BX2D.NCT	288.47
2 x 1 x 2-1/2	10	10	560	2X1X2D.BCT	164.63	2X1X2D.NCT	288.47
2 x 3/4 x 2-1/2	10	10	360	2XEX2D.BCT	164.61	2XEX2D.NCT	288.47
3 x 3 x 2-1/2	6	6	775	3X2D.BCT	247.41	3X2D.NCT	410.23
3 x 3 x 2	6	6	800	3X2.BCT	212.80	3X2.NCT	410.23
3 x 3 x 1-1/2	6	6	840	3X1D.BCT	247.41	3X1D.NCT	357.05
3 x 3 x 1-1/4	6	6	584	3X1B.BCT	227.98	3X1B.NCT	357.05
3 x 3 x 1	6	6	660	3X1.BCT	208.39	3X1.NCT	357.05
3 x 2-1/2 x 3	6	6	850	3X2DX3.BCT	247.41	3X2DX3.NCT	434.85
3 x 2-1/2 x 2-1/2	6	6	780	3X2DX2D.BCT	247.41	3X2DX2D.NCT	410.23
3 x 2-1/2 x 2	6	6	837	3X2DX2.BCT	247.41	3X2DX2.NCT	410.23
3 x 2-1/2 x 1-1/4	6	6	658	3X2DX1B.BCT	235.79	3X2DX1B.NCT	430.87
3 x 2 x 3	6	6	780	3X2X3.BCT	247.41	3X2X3.NCT	434.85
3 x 2 x 2-1/2	6	6	850	3X2X2D.BCT	235.79	3X2X2D.NCT	430.87
3 x 2 x 2	6	6	615	3X2X2.BCT	247.41	3X2X2.NCT	410.23
3 x 2 x 1-1/2	6	6	650	3X2X1D.BCT	247.41	3X2X1D.NCT	434.85
3 x 3 x 1/2	1	1	608	3XD.BCT	335.10		
3 x 3 x 3/4	1	1	595	3XE.BCT	335.10		
3 x 1-1/2 x 3	6	6	830	3X1DX3.BCT	247.41	3X1DX3.NCT	434.85
3 x 1-1/2 x 2	6	6	650	3X1DX2.BCT	247.44	3X1DX2.NCT	456.70
3 x 2-1/2 x 1-1/2	1	1	623	3X2DX1D.BCT	335.10		
3 x 1-1/2 x 1-1/2	6	6	675	3X1DX1D.BCT	247.44	3X1DX1D.NCT	375.00
3 x 1-1/4 x 3	6	6	838	3X1BX3.BCT	247.41	3X1BX3.NCT	434.85
3 x 1-1/4 x 2	6	6	600	3X1BX2.BCT	237.07		
3 x 1 x 3	6	6	822	3X1X3.BCT	247.41	3X1X3.NCT	434.85
3 x 1 x 2	6	6	580	3X1X2.BCT	247.41		
3 x 3 x 4	1	1	1280	3X4.BCT	607.54		
4 x 4 x 3	4	4	1410	4X3.BCT	482.52	4X3.NCT	869.60
4 x 4 x 2-1/2	4	4	1238	4X2D.BCT	455.22	4X2D.NCT	820.37
4 x 4 x 2	4	4	1117	4X2.BCT	435.71	4X2.NCT	869.60
4 x 4 x 1-1/2	4	4	1108	4X1D.BCT	493.98	4X1D.NCT	820.37
4 x 3-1/2 x 4	2	2	1805	4X3DX4.BCT	497.05	4X3DX4.NCT	1035.12
4 x 3 x 4	4	4	1500	4X3X4.BCT	493.98	4X3X4.NCT	820.37
4 x 2-1/2 x 4	4	4	1400	4X2DX4.BCT	493.98	4X2DX4.NCT	820.37
4 x 2 x 4	4	4	1360	4X2X4.BCT	493.98	4X2X4.NCT	869.60
4 x 4 x 3/4	1	1	1058	4XE.BCT	668.99		
4 x 4 x 1	1	1	980	4X1.BCT	616.41		
4 x 4 x 1-1/4	1	1	978	4X1B.BCT	556.66		
4 x 1-1/2 x 4	4	4	1325	4X1DX4.BCT	470.72	4X1DX4.NCT	869.60
4 x 1 x 4	4	4	1392	4X1X4.BCT	429.11	4X1X4.NCT	869.60
4 x 3 x 3	4	4	1160	4X3X3.BCT	650.59	4X3X3.NCT	869.60
4 x 3 x 2-1/2	4	4	1270	4X3X2D.BCT	470.72	4X3X2D.NCT	869.60
4 x 3 x 2	4	4	1200	4X3X2.BCT	506.04	4X3X2.NCT	869.60
4 x 3 x 1-1/2	4	4	1058	4X3X1D.BCT	506.04	4X3X1D.NCT	869.60
4 x 2-1/2 x 2-1/2	4	4	1083	4X2DX2D.BCT	605.24	4X2DX2D.NCT	820.37
4 x 2 x 2	4	4	875	4X2X2.BCT	506.04	4X2X2.NCT	869.60
5 x 5 x 2	1	1	1743	5X2.BCT	1147.78		
5 x 5 x 2-1/2	1	1	2093	5X2D.BCT	1114.11		
5 x 5 x 3	1	1	2000	5X3.BCT	1147.78		
5 x 5 x 4	1	1	2383	5X4.BCT	1114.11		
6 x 6 x 3	1	1	2670	6X3.BCT	1432.31		
6 x 6 x 4	1	1	3043	6X4.BCT	1475.51		
6 x 6 x 5	1	1	3523	6X5.BCT	1432.31		



**CAST IRON
REDUCING TEES
CLASS 250**

DESCRIPTION	PCS PER BOX	PCS PER MASTER	WEIGHT PER 100	PART # BLACK	PRICE (US\$) BLACK	PART # GALV.	PRICE (US\$) GALV.
1-1/4 x 1-1/4 x 3/4	1	1	321	1BXE.BC250T	176.17		
1-1/2 x 1-1/2 x 3/4	1	1	402	1DXE.BC250T	261.65		
2 x 2 x 3/4	1	1	615	2XE.BC250T	288.60		
2 x 2 x 1-1/2	1	1	760	2X1D.BC250T	355.78		



**CAST IRON
CROSSES
CLASS 125**

Fig. 30A

DESCRIPTION	PCS PER BOX	PCS PER MASTER	WEIGHT PER 100	PART # BLACK	PRICE (US\$) BLACK	PART # GALV.	PRICE (US\$) GALV.
1/2	50	50	87	D.BCCR	38.73	D.NCCR	67.40
3/4	30	30	130	E.BCCR	38.73	E.NCCR	55.34
1	25	25	178	1.BCCR	45.11	1.NCCR	93.90
1-1/4	15	15	295	1B.BCCR	63.63	1B.NCCR	103.63
1-1/4 x 1	15	15	215	1BX1.BCCR	73.13	1BX1.NCCR	132.04
1-1/2	10	10	350	1D.BCCR	88.30	1D.NCCR	159.21
1-1/2 x 1-1/4	1	1	280	1DX1B.BCCR	104.66		
1-1/2 x 1-1/4 x 1	1	1	303	1DX1BX1.BCCR	144.02		
1-1/2 x 1-1/4 x 1 x 1	1	1	268	1DX1BX1X1.BCCR	104.66		
1-1/2 x 1	10	10	262	1DX1.BCCR	86.97	1DX1.NCCR	160.76
1-1/2 x 1 x 1 x 1	1	1	280	1DX1X1X1.BCCR	121.53		
2	8	8	650	2.BCCR	116.93	2.NCCR	250.18
2 x 1	8	8	352	2X1.BCCR	119.07	2X1.NCCR	250.54
2 x 1-1/4	1	1	373	2X1B.BCCR	134.11		
2 x 1-1/2	1	1	410	2X1D.BCCR	120.13		
2 x 1-1/2 x 1 x 1	1	1	367	2X1DX1X1.BCCR	180.56		
4	1	1	1950	4.BCCR	862.22		



**CAST IRON
REDUCING
COUPLINGS
CLASS 125**

Fig. 29

DESCRIPTION	PCS PER BOX	PCS PER MASTER	WEIGHT PER 100	PART # BLACK	PRICE (US\$) BLACK	PART # GALV.	PRICE (US\$) GALV.
3/4 x 1/2	50	50	44	EXD.BR	25.21	EXD.NR	34.03
1 x 3/4	50	50	64	1XE.BR	17.09	1XE.NR	48.50
1 x 1/2	50	50	58	1XD.BR	12.90	1XD.NR	40.44
1-1/4 x 1	50	50	105	1BX1.BR	44.29	1BX1.NR	82.96
1-1/4 x 1/2	50	50	96	1BXD.BR	50.93		
1-1/4 x 3/4	50	50	99	1BXE.BR	37.86	1BXE.NR	81.59
1-1/2 x 1/2	1	1	397	1DXD.BR	80.01		
1-1/2 x 3/4	40	40	120	1DXE.BR	72.00	1DXE.NR	241.97
1-1/2 x 1	40	40	150	1DX1.BR	62.69	1DX1.NR	122.64
1-1/2 x 1-1/4	40	40	135	1DX1B.BR	62.69	1DX1B.NR	122.64
2 x 1-1/2	30	30	209	2X1D.BR	81.99	2X1D.NR	139.69
2 x 1-1/4	30	30	204	2X1B.BR	85.66	2X1B.NR	170.13
2 x 1	30	30	172	2X1.BR	73.00	2X1.NR	166.95
2 x 3/4	30	30	172	2XE.BR	81.99	2XE.NR	160.51
2 x 1/2	30	30	175	2XD.BR	91.02	2XD.NR	160.51
2-1/2 x 2	18	18	300	2DX2.BR	116.52	2DX2.NR	185.96
2-1/2 x 1-1/2	18	18	325	2DX1D.BR	129.57	2DX1D.NR	213.67
3 x 2	12	12	435	3X2.BR	142.81	3X2.NR	231.10
3 x 1-1/2	12	12	458	3X1D.BR	197.78	3X1D.NR	241.34
3 x 2-1/2	1	1	440	3X2D.BR	184.80		
4 x 2	1	1	605	4X2.BR	378.77		
4 x 2-1/2	1	1	780	4X2D.BR	378.77		
4 x 3	1	1	700	4X3.BR	378.77		
6 x 4	1	1	1335	6X4.BR	686.55		

**CAST IRON
ECCENTRIC
REDUCERS
CLASS 125**

Fig. 29E

DESCRIPTION	PCS PER BOX	PCS PER MASTER	WEIGHT PER 100	PART # BLACK	PRICE (US\$) BLACK	PART # GALV.	PRICE (US\$) GALV.
3/4 x 1/2	50	50	45	EXD.BER	53.05	EXD.NER	95.50
1 x 3/4	50	50	69	1XE.BER	57.29	1XE.NER	103.12
1 x 1/2	50	50	64	1XD.BER	55.69	1XD.NER	110.27
1-1/4 x 1	50	50	89	1BX1.BER	85.33	1BX1.NER	153.60
1-1/4 x 3/4	50	50	96	1BXE.BER	82.93	1BXE.NER	149.27
1-1/4 x 1/2	50	50	91	1BXD.BER	91.52	1BXD.NER	164.76
1-1/2 x 1-1/4	40	40	141	1DX1B.BER	115.69	1DX1B.NER	208.22
1-1/2 x 1	40	40	127	1DX1.BER	120.99	1DX1.NER	217.79
1-1/2 x 3/4	40	40	110	1DXE.BER	120.99	1DXE.NER	217.79
1-1/2 x 1/2	40	40	117	1DXD.BER	115.23	1DXD.NER	230.47
2 x 1/2	1	1	183	2XD.BER	154.65		
2 x 3/4	25	25	185	2XE.BER	174.33	2XE.NER	348.65
2 x 1	30	30	195	2X1.BER	157.93	2X1.NER	277.10
2 x 1-1/4	30	30	205	2X1B.BER	150.39	2X1B.NER	270.71
2 x 1-1/2	30	30	198	2X1D.BER	153.41	2X1D.NER	276.15
2-1/2 x 1	1	1	258	2DX1.BER	239.85		
2-1/2 x 1-1/4	1	1	265	2DX1B.BER	239.85		
2-1/2 x 1-1/2	1	1	265	2DX1D.BER	239.85		
2-1/2 x 2	1	1	308	2DX2.BER	234.26		
3 x 1	1	1	367	3X1.BER	378.77		
3 x 1-1/4	1	1	388	3X1B.BER	378.77		
3 x 1-1/2	1	1	383	3X1D.BER	322.70		
3 x 2	1	1	403	3X2.BER	290.44		
3 x 2-1/2	1	1	468	3X2D.BER	349.04		
4 x 1-1/4	1	1	658	4X1B.BER	683.36		
4 x 1-1/2	1	1	661	4X1D.BER	635.69		
4 x 2	1	1	600	4X2.BER	683.36		



Fig. 30

**CAST IRON
PIPE CAPS
CLASS 125**

DESCRIPTION	PCS PER BOX	PCS PER MASTER	WEIGHT PER 100	PART # BLACK	PRICE (US\$) BLACK	PART # GALV.	PRICE (US\$) GALV.
2-1/2	6	6	225	2D.BCCAP	77.24	2D.NCCAP	133.13
3	6	6	375	3.BCCAP	101.62	3.NCCAP	169.31
4	5	5	600	4.BCCAP	146.17	4.NCCAP	273.67
5	6	6	1014	5.BCCAP	222.55	5.NCCAP	429.53
6	3	3	1910	6.BCCAP	278.85	6.NCCAP	1104.61
8	1	1	2825	8.BCCAP	790.49	8.NCCAP	1545.38

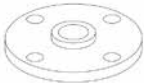

Fig. 20

**COMPANION
FLANGES
THREADED
CLASS 125**

DESCRIPTION	PCS PER BOX	PCS PER MASTER	WEIGHT PER 100	PART # BLACK	PRICE (US\$) BLACK	PART # GALV.	PRICE (US\$) GALV.
1x4-1/4	10	10	166	1X4B.BCF	69.21	1X4B.NCF	156.67
1-1/4x4-5/8	10	10	205	1B.BCF	82.81	1B.NCF	179.86
1-1/2x5	10	10	261	1DX5.BCF	76.53	1DX5.NCF	184.01
2x6	6	6	444	2X6.BCF	76.37	2X6.NCF	161.82
2-1/2x7	6	6	607	2DX7.BCF	89.35	2DX7.NCF	189.31
3x7-1/2	5	5	764	3X7D.BCF	115.09	3X7D.NCF	230.05
4x9	5	5	1188	4X9.BCF	155.10	4X9.NCF	313.33
5x10	1	1	1358	5X10.BCF	219.11	5X10.NCF	491.91
6x11	3	3	1745	6X11.BCF	247.90	6X11.NCF	525.78
8x13-1/2	1	1	3000	8X13D.BCF	391.30	8X13D.NCF	912.98
10x16	1	1	4200	10X16.BCF	693.49	10X16.NCF	1375.07

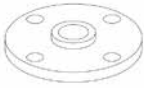

Fig. 71

**CAST IRON
REDUCING
FLANGES
THREADED
CLASS 125**

DESCRIPTION	PCS PER BOX	PCS PER MASTER	WEIGHT PER 100	PART # BLACK	PRICE (US\$) BLACK	PART # GALV.	PRICE (US\$) GALV.
3/4x5	10	10	300	EX5.BRF	200.05	EX5.NRF	326.01
1x5	10	10	300	1X5.BRF	204.54	1X5.NRF	326.01
1x6	6	6	450	1X6.BRF	194.96	1X6.NRF	311.37
1-1/4x6	6	6	400	1BX6.BRF	186.82	1BX6.NRF	315.89
1-1/2x6	6	6	425	1DX6.BRF	159.90	1DX6.NRF	315.89
1-1/2x7	6	6	637	1DX7.BRF	206.17	1DX7.NRF	322.30
2x7	6	6	615	2X7.BRF	149.59	2X7.NRF	348.09
1x7-1/2	5	5	810	1X7D.BRF	295.12	1X7D.NRF	473.49
1-1/4x7-1/2	5	5	800	1BX7D.BRF	295.12	1BX7D.NRF	456.38
1-1/2x7-1/2	5	5	825	1DX7D.BRF	247.18	1DX7D.NRF	489.43
2x7-1/2	5	5	800	2X7D.BRF	199.45	2X7D.NRF	468.98
2-1/2x7-1/2	5	5	800	2DX7D.BRF	214.04	2DX7D.NRF	489.43
1-1/2x9	5	5	1394	1DX9.BRF	365.10	1DX9.NRF	620.01
2x9	1	1	1403	2X9.BRF	271.09	2X9.NRF	657.06
2-1/2x9	1	1	1450	2DX9.BRF	290.89	2DX9.NRF	620.01
3x9	1	1	1313	3X9.BRF	271.09	3X9.NRF	657.06
3-1/2x9	5	5	1250	3DX9.BRF	328.80	3DX9.NRF	673.60
2x10	1	1	1850	2X10.BRF	499.61	2X10.NRF	799.71
2-1/2x10	1	1	1850	2DX10.BRF	499.61	2DX10.NRF	799.71
3x10	1	1	1750	3X10.BRF	501.11	3X10.NRF	783.46
4x10	1	1	1600	4X10.BRF	419.49	4X10.NRF	842.21
1-1/2x11	1	1	2410	1DX11.BRF	642.62	1DX11.NRF	1067.19
2x11	1	1	2450	2X11.BRF	495.77	2X11.NRF	988.56
2-1/2x11	1	1	2225	2DX11.BRF	589.04	2DX11.NRF	1060.69
3x11	1	1	2200	3X11.BRF	495.77	3X11.NRF	988.56
4x11	1	1	2012	4X11.BRF	408.86	4X11.NRF	978.88
5x11	1	1	1900	5X11.BRF	518.19	5X11.NRF	988.56
2x13-1/2	1	1	3080	2X13D.BRF	908.67	2X13D.NRF	1638.82
3x13-1/2	1	1	3900	3X13D.BRF	908.67	3X13D.NRF	1628.84
4x13-1/2	1	1	4056	4X13D.BRF	699.82	4X13D.NRF	1452.37
5x13-1/2	1	1	4000	5X13D.BRF	982.22	5X13D.NRF	1483.46
6x13-1/2	1	1	3800	6X13D.BRF	634.39	6X13D.NRF	1560.97

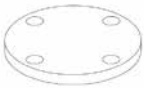

Fig. 19

**CAST IRON
BLIND FLANGES
CLASS 125**

DESCRIPTION	PCS PER BOX	PCS PER MASTER	WEIGHT PER 100	PART # BLACK	PRICE (US\$) BLACK	PART # GALV.	PRICE (US\$) GALV.
1-1/4 x 4 5/8	10	10	200	1B.BBF	116.39	1B.NBF	206.14
1-1/2 x 5	10	10	275	1DX5.BBF	123.56	1DX5.NBF	210.13
1x4-1/4	10	10	150	1X4B.BBF	110.16	1X4B.NBF	188.69
2 x 6	6	6	450	2X6.BBF	139.60	2X6.NBF	218.62
2-1/2 x 7	6	6	675	2DX7.BBF	153.43	2DX7.NBF	254.98
3 x 7-1/2	5	5	850	3X7D.BBF	183.89	3X7D.NBF	318.22
4 x 9	1	1	1456	4X9.BBF	235.54	4X9.NBF	445.38
5 x 10	1	1	2000	5X10.BBF	382.70	5X10.NBF	727.14
6 x 11	1	1	2475	6X11.BBF	416.33	6X11.NBF	771.94
8 x 13-1/2	1	1	4000	8X13D.BBF	653.21	8X13D.NBF	1020.52
10 x 16	1	1	6044	10X16.BBF	966.34	10X16.NBF	1704.87



Fig. 15

**CAST IRON
FLOOR FLANGES
CLASS 125**

DESCRIPTION	PCS PER BOX	PCS PER MASTER	WEIGHT PER 100	PART # BLACK	PRICE (US\$) BLACK	PART # GALV.	PRICE (US\$) GALV.
3/8	25	150	36	C.BCFF	* 22.63	C.NCFF	44.02
1/2	30	120	46	D.BCFF	* 23.28	D.NCFF	58.13
3/4	30	120	48	E.BCFF	* 23.28	E.NCFF	58.13
1	30	60	87	1.BCFF	* 29.21	1.NCFF	53.05
1-1/4	30	60	80	1B.BCFF	* 29.21	1B.NCFF	70.51
1-1/2	20	40	137	1D.BCFF	* 37.61	1D.NCFF	90.37
2	15	30	215	2.BCFF	* 45.23	2.NCFF	114.72
3	10	10	225	3.BCFF	33.82		
4	10	10	450	4.BCFF	66.20		771.94



Fig. 14

**CAST IRON
FLANGES
UNIONS
CLASS 125**

DESCRIPTION	PCS PER BOX	PCS PER MASTER	WEIGHT PER 100	PART # BLACK	PRICE (US\$) BLACK	PART # GALV.	PRICE (US\$) GALV.
1/2	1	1	150	D.BFU	120.99	D.NFU	309.01
3/4	1	1	250	E.BFU	168.62	E.NFU	354.23
1	1	1	225	1.BFU	163.37	1.NFU	354.23
1-1/4	1	1	329	1B.BFU	193.23	1B.NFU	443.60
1-1/2	7	7	350	1D.BFU	178.32	1D.NFU	546.97
2	7	7	600	2.BFU	209.89	2.NFU	562.91
2-1/2	4	4	1000	2D.BFU	284.21	2D.NFU	847.28
3-1/2	4	4	1250	3D.BFU	545.44	3D.NFU	1459.70
3	4	4	1115	3.BFU	321.50	3.NFU	1123.28
4	3	3	1450	4.BFU	437.18	4.NFU	1490.26
5	2	2	2500	5.BFU	1018.93	5.NFU	1671.49
6	2	2	2850	6.BFU	956.46	6.NFU	1909.77



**CAST IRON
90° ELBOWS
CLASS 250**

DESCRIPTION	PCS PER BOX	PCS PER MASTER	WEIGHT PER 100	PART # BLACK	PRICE (US\$) BLACK	PART # GALV.	PRICE (US\$) GALV.
1/2	1	1	75	D.BC250L	46.44		
3/4	1	1	157	E.BC250L	47.28		
1	1	1	169	1.BC250L	57.18		
1-1/4	1	1	292	1B.BC250L	85.13		
1-1/2	1	1	386	1D.BC250L	105.61		
2	1	1	643	2.BC250L	130.32		
2-1/2	1	1	1056	2D.BC250L	316.35		

**CAST IRON
45° ELBOWS
CLASS 250**

DESCRIPTION	PCS PER BOX	PCS PER MASTER	WEIGHT PER 100	PART # BLACK	PRICE (US\$) BLACK	PART # GALV.	PRICE (US\$) GALV.
1/2	1	1	67	D.BC25045L	66.18		
3/4	1	1	104	E.BC25045L	63.90		
1	1	1	160	1.BC25045L	76.70		
1-1/4	1	1	270	1B.BC25045L	126.41		
1-1/2	1	1	355	1D.BC25045L	139.07		
2	1	1	617	2.BC25045L	197.78		
2-1/2	1	1	938	2D.BC25045L	341.51		



**CAST IRON
STRAIGHT TEES
CLASS 250**

DESCRIPTION	PCS PER BOX	PCS PER MASTER	WEIGHT PER 100	PART # BLACK	PRICE (US\$) BLACK	PART # GALV.	PRICE (US\$) GALV.
3/8	1	1	70	C.BC250T	75.67		
1/2	1	1	101	D.BC250T	72.55		
3/4	1	1	153	E.BC250T	72.49		
1	1	1	243	1.BC250T	87.52		
1-1/4	1	1	394	1B.BC250T	130.53		
1-1/2	1	1	531	1D.BC250T	167.95		
2	1	1	873	2.BC250T	208.35		
2-1/2	1	1	1423	2D.BC250T	444.60		



Fig. 31

**CAST IRON
DRAINAGE SHORT
TURN 90° ELBOWS**

DESCRIPTION	PCS PER BOX	PCS PER MASTER	WEIGHT PER 100	PART # BLACK	PRICE (US\$) BLACK	PART # GALV.	PRICE (US\$) GALV.
1-1/2	25	25	193	1D.BDL	54.18	1D.NDL	80.29
2	15	15	301	2.BDL	81.60	2.NDL	116.02
3	6	6	750	3.BDL	306.48	3.NDL	458.64
4	2	2	1150	4.BDL	485.39	4.NDL	892.63
2x1-1/2	20	20	275	2X1D.BDL	* 110.85	2X1D.NDL	127.51



Fig. 33

**DRAINAGE LONG
TURN 90° ELBOWS**

DESCRIPTION	PCS PER BOX	PCS PER MASTER	WEIGHT PER 100	PART # BLACK	PRICE (US\$) BLACK	PART # GALV.	PRICE (US\$) GALV.
1-1/2	15	15	216	1D.BDLTL	75.81	1D.NDLTL	91.30
2	10	10	360	2.BDLTL	112.89	2.NDLTL	156.73
3	5	5	838	3.BDLTL	* 411.74	3.NDLTL	484.95



Fig. 78

**DRAINAGE EXTRA
LONG TURN 90°
ELBOWS**

DESCRIPTION	PCS PER BOX	PCS PER MASTER	WEIGHT PER 100	PART # BLACK	PRICE (US\$) BLACK	PART # GALV.	PRICE (US\$) GALV.
1-1/2	15	15	324	1D.BDXLTL	97.90	1D.NDXLTL	139.12
2	10	10	415	2.BDXLTL	169.31	2.NDXLTL	222.70



Fig. 37

**DRAINAGE SHORT
TURN 60° ELBOWS**

DESCRIPTION	PCS PER BOX	PCS PER MASTER	WEIGHT PER 100	PART # BLACK	PRICE (US\$) BLACK	PART # GALV.	PRICE (US\$) GALV.
1-1/2	25	25	182	1D.BD60L	98.07	1D.ND60L	152.15
2	15	15	270	2.BD60L	112.56	2.ND60L	148.89



Fig. 32

**DRAINAGE SHORT
TURN 45° ELBOWS**

DESCRIPTION	PCS PER BOX	PCS PER MASTER	WEIGHT PER 100	PART # BLACK	PRICE (US\$) BLACK	PART # GALV.	PRICE (US\$) GALV.
1-1/4	25	25	135	1B.BD45L	50.81	1B.ND45L	77.72
1-1/2	25	25	168	1D.BD45L	52.96	1D.ND45L	79.36
2	15	15	257	2.BD45L	76.47	2.ND45L	113.57
3	6	6	694	3.BD45L	299.47	3.ND45L	395.26
4	2	2	1100	4.BD45L	468.11	4.ND45L	645.85



Fig. 34

**DRAINAGE LONG
TURN 45° ELBOWS**

DESCRIPTION	PCS PER BOX	PCS PER MASTER	WEIGHT PER 100	PART # BLACK	PRICE (US\$) BLACK	PART # GALV.	PRICE (US\$) GALV.
1-1/2	15	15	210	1D.BDLT45L	74.43	1D.NDLT45L	90.33
2	10	10	310	2.BDLT45L	* 126.89	2.NDLT45L	159.37



Fig. 74

**DRAINAGE SHORT
TURN 22-1/2°
ELBOWS**

DESCRIPTION	PCS PER BOX	PCS PER MASTER	WEIGHT PER 100	PART # BLACK	PRICE (US\$) BLACK	PART # GALV.	PRICE (US\$) GALV.
1-1/2	25	25	149	1D.BD22L	66.76	1D.ND22L	86.07
2	15	15	260	2.BD22L	88.93	2.ND22L	128.73



Fig. 75

**DRAINAGE SHORT
TURN 11-1/4°
ELLS**

DESCRIPTION	PCS PER BOX	PCS PER MASTER	WEIGHT PER 100	PART # BLACK	PRICE (US\$) BLACK	PART # GALV.	PRICE (US\$) GALV.
1-1/2	25	25	149	1D.BD22L	66.76	1D.ND22L	86.07



Fig. 35

**DRAINAGE STREET
90° ELBOWS**

DESCRIPTION	PCS PER BOX	PCS PER MASTER	WEIGHT PER 100	PART # BLACK	PRICE (US\$) BLACK	PART # GALV.	PRICE (US\$) GALV.
1-1/2	25	25	180	1D.BDSTL	77.24	1D.NDSTL	101.69
2	15	15	260	2.BDSTL	102.27	2.NDSTL	159.36



Fig. 36

**DRAINAGE STREET
45° ELBOWS**

DESCRIPTION	PCS PER BOX	PCS PER MASTER	WEIGHT PER 100	PART # BLACK	PRICE (US\$) BLACK	PART # GALV.	PRICE (US\$) GALV.
1-1/2	25	25	155	1D.BDST45L	72.14	1D.NDST45L	105.23
2	15	15	240	2.BDST45L	116.77	2.NDST45L	161.93



Fig. 38

DRAINAGE TEES

DESCRIPTION	PCS PER BOX	PCS PER MASTER	WEIGHT PER 100	PART # BLACK	PRICE (US\$) BLACK	PART # GALV.	PRICE (US\$) GALV.
1-1/2	15	15	270	1D.BDT	89.03	1D.NDT	120.72
2	10	10	425	2.BDT	147.20	2.NDT	202.03
2x1-1/2	10	10	350	2X1D.BDT	* 167.61	2X1D.NDT	227.97



Fig. 39

DRAINAGE SHORT TURN 90° TYS

DESCRIPTION	PCS PER BOX	PCS PER MASTER	WEIGHT PER 100	PART # BLACK	PRICE (US\$) BLACK	PART # GALV.	PRICE (US\$) GALV.
1-1/2	15	15	320	1D.BDTY	87.43	1D.NDTY	122.18
2	10	10	488	2.BDTY	144.10	2.NDTY	199.67
4	1	1	2000	4.BDTY	786.18	4.NDTY	963.85
2x1-1/2	10	10	370	2X1D.BDTY	148.16	2X1D.NDTY	229.22
2x1-1/2x1-1/2	10	10	350	2X1DX1D.BDTY	148.16	2X1DX1D.NDTY	216.24
2x1-1/2x2	10	10	475	2X1DX2.BDTY	148.16	2X1DX2.NDTY	216.24



Fig. 40

DRAINAGE LONG TURN 90° TYS

DESCRIPTION	PCS PER BOX	PCS PER MASTER	WEIGHT PER 100	PART # BLACK	PRICE (US\$) BLACK	PART # GALV.	PRICE (US\$) GALV.
1-1/2	10	10	440	1D.BDLTTY	* 146.10	1D.NDLTTY	203.01
2	6	6	700	2.BDLTTY	227.82	2.NDLTTY	368.15
2 x 1-1/2	8	8	500	2X1D.BDLTTY	239.11	2X1D.NDLTTY	368.17
2 x 1-1/2 x 1-1/2			500			2X1DX1D.NDLTTY	392.49
2 x 1-1/2 x 2	8	8	740	2X1DX2.BDLTTY	196.82		



Fig. 41

DRAINAGE SHORT TURN 45° Y BRANCHES

DESCRIPTION	PCS PER BOX	PCS PER MASTER	WEIGHT PER 100	PART # BLACK	PRICE (US\$) BLACK	PART # GALV.	PRICE (US\$) GALV.
1-1/2	15	15	360	1D.BDY	107.07	1D.NDY	135.53
2	10	10	509	2.BDY	199.70	2.NDY	271.70
3	1	1	1345	3.BDY	688.77	3.NDY	963.43
4	1	1	2400	4.BDY	1027.71	4.NDY	1478.13
2 x 1-1/2 x 1-1/2	10	10	452	2X1DX1D.BDY	224.44	2X1DX1D.NDY	304.51
2 x 2 x 1-1/2	10	10	450	2X1D.BDY	197.46	2X1D.NDY	240.00
2 x 1-1/2 x 2	10	10	585	2X1DX2.BDY	184.29		
4 x 3	1	1	2000	4X3.BDY	1073.19	4X3.NDY	1509.97



Fig. 42

DRAINAGE DOUBLE 90° Y BRANCHES

DESCRIPTION	PCS PER BOX	PCS PER MASTER	WEIGHT PER 100	PART # BLACK	PRICE (US\$) BLACK	PART # GALV.	PRICE (US\$) GALV.
1-1/2	10	10	376	1D.BDDY	209.30	1D.NDDY	259.60
2	8	8	650	2.BDDY	214.55	2.NDDY	302.85
2 x 1-1/2	8	8	513	2X1D.BDDY	220.14	2X1D.NDDY	302.85



Fig. 45

DRAINAGE P TRAP WITH CLEANOUT

DESCRIPTION	PCS PER BOX	PCS PER MASTER	WEIGHT PER 100	PART # BLACK	PRICE (US\$) BLACK	PART # GALV.	PRICE (US\$) GALV.
1-1/2	10	10	469	1D.BDPT	159.09	1D.NDPT	219.17
2	8	8	600	2.BDPT	254.71	2.NDPT	383.63



Fig. 46

P TRAP WITHOUT DRAIN

DESCRIPTION	PCS PER BOX	PCS PER MASTER	WEIGHT PER 100	PART # BLACK	PRICE (US\$) BLACK	PART # GALV.	PRICE (US\$) GALV.
1-1/2	10	10	380	1D.BDPTWO	163.68	1D.NDPTWO	215.39
2	8	8	647	2.BDPTWO	262.00	2.NDPTWO	377.05



FLANGED 90° ELLS

DESCRIPTION	PCS PER BOX	PCS PER MASTER	WEIGHT PER 100	PART # BLACK	PRICE (US\$) BLACK	PART # GALV.	PRICE (US\$) GALV.
2	1	1	1300	2.BFL	474.38	2.NFL	984.41
2-1/2	1	1	1900	2D.BFL	513.13	2D.NFL	1346.62
3	1	1	2700	3.BFL	428.29	3.NFL	1327.47
4	1	1	4000	4.BFL	529.67	4.NFL	1210.22
5	1	1	5700	5.BFL	1254.46	5.NFL	2550.78
6	1	1	7000	6.BFL	829.31	6.NFL	1948.48
8	1	1	11600	8.BFL	1431.99	8.NFL	3035.01
10	1	1	17700	10.BFL	3138.46	10.NFL	5616.26
12	1	1	24800	12.BFL	6317.91	12.NFL	9371.63
3X2-1/2	1	1	2300	3X2D.BFL	1586.74	3X2D.NFL	1948.91
3X2	1	1	2100	3X2.BFL	1454.54	3X2.NFL	1721.50
4X3	1	1	3500	4X3.BFL	1175.05	4X3.NFL	1829.88
4X2-1/2	1	1	3500	4X2D.BFL	1795.93	4X2D.NFL	2125.61
4X2	1	1	3200	4X2.BFL	1795.93	4X2.NFL	2125.61
5X4	1	1	6500	5X4.BFL	2389.56		
6X5	1	1	6600	6X5.BFL	2475.59	6X5.NFL	2930.37
6X4	1	1	6700	6X4.BFL	1457.18	6X4.NFL	2952.33
6X3	1	1	5900	6X3.BFL	2588.13	6X3.NFL	3495.43
8X6	1	1	9200	8X6.BFL	2126.06	8X6.NFL	4192.57
8X5	1	1	9200	8X5.BFL	3787.40	8X5.NFL	5115.17
8X4	1	1	8900	8X4.BFL	2866.99	8X4.NFL	4974.11
10X8	1	1	16000	10X8.BFL	4048.14	10X8.NFL	7765.89
10X6	1	1	15500	10X6.BFL	5913.31	10X6.NFL	7986.01
12X6	1	1	23400	12X6.BFL	11229.48		
12X10	1	1	23700	12X10.BFL	7757.49	12X10.NFL	13467.01
12X8	1	1	23400	12X8.BFL	10251.24	12X8.NFL	13844.49



FLANGED LONG RADIUS 90° ELLS

DESCRIPTION	PCS PER BOX	PCS PER MASTER	WEIGHT PER 100	PART # BLACK	PRICE (US\$) BLACK	PART # GALV.	PRICE (US\$) GALV.
2	1	1	1500	2.BFLL	1277.46	2.NFLL	1650.21
3	1	1	2800	3.BFLL	1379.98	3.NFLL	2337.85
4	1	1	4700	4.BFLL	1265.57	4.NFLL	3312.26
6	1	1	9200	6.BFLL	1830.59	6.NFLL	3519.28
8	1	1	13400	8.BFLL	3518.61	8.NFLL	6122.38
10	1	1	21600	10.BFLL	5477.46	10.NFLL	9509.81
12	1	1	35600	12.BFLL	11286.52	12.NFLL	18726.80



FLANGED LONG RADIUS 90° REDUCING ELLS

DESCRIPTION	PCS PER BOX	PCS PER MASTER	WEIGHT PER 100	PART # BLACK	PRICE (US\$) BLACK	PART # GALV.	PRICE (US\$) GALV.
4X3	1	1	4200	4X3.BFLL	3012.39	4X3.NFLL	3519.48
6X4	1	1	8100	6X4.BFLL	3931.88	6X4.NFLL	5310.07
8X6	1	1	13000	8X6.BFLL	7267.79	8X6.NFLL	9424.72



FLANGED 90° BASE ELLS

DESCRIPTION	PCS PER BOX	PCS PER MASTER	WEIGHT PER 100	PART # BLACK	PRICE (US\$) BLACK	PART # GALV.	PRICE (US\$) GALV.
4	1	1	5200	4.BFBL	2058.15	4.NFBL	2779.48
6	1	1	8800	6.BFBL	3506.60	6.NFBL	4735.82
8	1	1	15300	8.BFBL	4647.13	8.NFBL	6273.38
10	1	1	22700	10.BFBL	7802.62	10.NFBL	10079.54
12	1	1	34000	12.BFBL	10745.39		



FLANGED 45° ELLS

DESCRIPTION	PCS PER BOX	PCS PER MASTER	WEIGHT PER 100	PART # BLACK	PRICE (US\$) BLACK	PART # GALV.	PRICE (US\$) GALV.
2	1	1	1100	2.BF45L	687.36	2.NF45L	1269.12
2-1/2	1	1	1900	2D.BF45L	733.14	2D.NF45L	1252.48
3	1	1	2100	3.BF45L	712.94	3.NF45L	1408.34
4	1	1	3700	4.BF45L	802.45	4.NF45L	1747.34
5	1	1	3700	5.BF45L	1922.83	5.NF45L	3158.00
6	1	1	6000	6.BF45L	1311.89	6.NF45L	2437.45
8	1	1	9600	8.BF45L	1918.41	8.NF45L	3655.80
10	1	1	14700	10.BF45L	4053.69	10.NF45L	6996.79
12	1	1	21200	12.BF45L	6194.02	12.NF45L	10686.91



FLANGED 22-1/2° ELLS

DESCRIPTION	PCS PER BOX	PCS PER MASTER	WEIGHT PER 100	PART # BLACK	PRICE (US\$) BLACK	PART # GALV.	PRICE (US\$) GALV.
4	1	1	3530	4.BF22L	900.68	4.NF22L	1728.64
6	1	1	5730	6.BF22L	1300.48	6.NF22L	2496.88
8	1	1	9230	8.BF22L	1951.07	8.NF22L	3745.67
12	1	1	21610	12.BF22L	6128.21	12.NF22L	10134.04

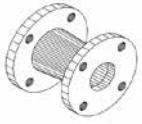

FLANGED CONCENTRIC REDUCERS

DESCRIPTION	PCS PER BOX	PCS PER MASTER	WEIGHT PER 100	PART # BLACK	PRICE (US\$) BLACK	PART # GALV.	PRICE (US\$) GALV.
2-1/2X2	1	1	1400	2DX2.BFCRD	1197.26	2DX2.NFCRD	1898.28
3X2-1/2	1	1	2000	3X2D.BFCRD	950.47	3X2D.NFCRD	1558.63
3X2	1	1	1700	3X2.BFCRD	950.47	3X2.NFCRD	1624.10
4X3	1	1	2900	4X3.BFCRD	1067.93	4X3.NFCRD	1895.71
4X2-1/2	1	1	2700	4X2D.BFCRD	1148.74	4X2D.NFCRD	2250.56
4X2	1	1	2400	4X2.BFCRD	1269.62	4X2.NFCRD	2250.56
5X3	1	1	4100	5X3.BFCRD	1878.33	5X3.NFCRD	3310.68
5X4	1	1	4000	5X4.BFCRD	1651.31	5X4.NFCRD	2937.23
6X5	1	1	5200	6X5.BFCRD	1571.03	6X5.NFCRD	3185.85
6X4	1	1	5000	6X4.BFCRD	1430.19	6X4.NFCRD	2762.03
6X3	1	1	4200	6X3.BFCRD	1646.40	6X3.NFCRD	3246.89
6X2-1/2	1	1	3900	6X2D.BFCRD	2172.06	6X2D.NFCRD	3751.05
6X2	1	1	3900	6X2.BFCRD	2871.90	6X2.NFCRD	4769.85
8X6	1	1	8000	8X6.BFCRD	1799.95	8X6.NFCRD	3197.82
8X5	1	1	7500	8X5.BFCRD	3259.26	8X5.NFCRD	4468.10
8X4	1	1	7400	8X4.BFCRD	2073.47	8X4.NFCRD	4176.57
10X8	1	1	12000	10X8.BFCRD	3712.05	10X8.NFCRD	7319.05
10X6	1	1	10800	10X6.BFCRD	4043.10	10X6.NFCRD	8132.34
12X10	1	1	19500	12X10.BFCRD	6402.70	12X10.NFCRD	12289.16
12X8	1	1	15800	12X8.BFCRD	7076.77	12X8.NFCRD	12289.16
12X6	1	1	15300	12X6.BFCRD	7399.21	12X6.NFCRD	12848.01



FLANGED ECCENTRIC REDUCERS

DESCRIPTION	PCS PER BOX	PCS PER MASTER	WEIGHT PER 100	PART # BLACK	PRICE (US\$) BLACK	PART # GALV.	PRICE (US\$) GALV.
3X2	1	1	1700	3X2.BFERD	1433.77	3X2.NFERD	1936.33
3x2-1/2	1	1	1600	3X2D.BFERD	1454.54	3X2D.NFERD	1937.52
4X3	1	1	2800	4X3.BFERD	1733.33	4X3.NFERD	2587.28
4X2	1	1	2500	4X2.BFERD	2002.90	4X2.NFERD	2587.28
4X2-1/2	1	1	2500	4X2D.BFERD	2017.27		
6X5	1	1	5500	6X5.BFERD	1637.20	6X5.NFERD	3229.72
6X4	1	1	4900	6X4.BFERD	1637.20	6X4.NFERD	3076.33
6X3	1	1	4400	6X3.BFERD	2732.81	6X3.NFERD	3690.50
8X6	1	1	8400	8X6.BFERD	2073.89	8X6.NFERD	3893.55
8X5	1	1	7500	8X5.BFERD	2690.16	8X5.NFERD	4671.03
8X4	1	1	7300	8X4.BFERD	2812.39	8X4.NFERD	4671.03
10X8	1	1	12500	10X8.BFERD	5282.72	10X8.NFERD	8004.33
10X6	1	1	11200	10X6.BFERD	6196.16	10X6.NFERD	8368.09
12X10	1	1	18500	12X10.BFERD	7160.72	12X10.NFERD	10952.20
12X8	1	1	16700	12X8.BFERD	7416.48	12X8.NFERD	12877.86



**STANDARD
FLANGED TEES**

DESCRIPTION	PCS PER BOX	PCS PER MASTER	WEIGHT PER 100	PART # BLACK	PRICE (US\$) BLACK	PART # GALV.	PRICE (US\$) GALV.
2	1	1	1700	2.BFT	519.41	2.NFT	928.81
2-1/2	1	1	2700	2D.BFT	756.51	2D.NFT	1254.10
3	1	1	4400	3.BFT	530.19	3.NFT	1259.18
4	1	1	6400	4.BFT	806.49	4.NFT	1993.44
5	1	1	8300	5.BFT	2160.47	5.NFT	2960.41
6	1	1	10500	6.BFT	1170.36	6.NFT	2740.88
8	1	1	16300	8.BFT	1999.51	8.NFT	4321.22
10	1	1	26000	10.BFT	5380.14	10.NFT	8201.68
12	1	1	40200	12.BFT	8451.65	12.NFT	12529.11

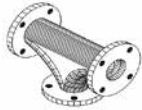

**REDUCING
FLANGED TEES**

DESCRIPTION	PCS PER BOX	PCS PER MASTER	WEIGHT PER 100	PART # BLACK	PRICE (US\$) BLACK	PART # GALV.	PRICE (US\$) GALV.
3X3X2-1/2	1	1	3800	3X2D.BFT	1573.90	3X2D.NFT	2146.72
3 X3X2	1	1	3400	3X2.BFT	1232.03	3X2.NFT	2139.60
4X4X6	1	1	8300	4X6.BFT	3205.62	4X6.NFT	4209.97
4 X4X3	1	1	5900	4X3.BFT	1660.00	4X3.NFT	2880.13
4 X3X4	1	1	5500	4X3X4.BFT	3969.66		
4 X4X2-1/2	1	1	5500	4X2D.BFT	1812.86	4X2D.NFT	3013.14
4X4X2	1	1	5400	4X2.BFT	1660.00	4X2.NFT	2761.20
6X4X6	1	1	9500	6X4X6.BFT	1841.23	6X4X6.NFT	3632.31
6X4X3	1	1	8600	6X4X3.BFT	671.53		
6X4X4	1	1	9000	6X4X4.BFT	2035.10	6X4X4.NFT	3610.22
6X6X8	1	1	13800	6X8.BFT	3964.07	6X8.NFT	6884.32
6X6X4	1	1	9600	6X4.BFT	1598.06	6X4.NFT	3108.80
6X6X3	1	1	9700	6X3.BFT	2324.76	6X3.NFT	4035.78
6X6X2-1/2	1	1	8800	6X2D.BFT	3110.48	6X2D.NFT	4021.23
6X6X2	1	1	8700	6X2.BFT	3266.04	6X2.NFT	4217.67
8X4X8	1	1	13800	8X4X8.BFT	5343.74		
8X6X8	1	1	14900	8X6X8.BFT	3964.07	8X6X8.NFT	7122.16
8X6X6	1	1	13900	8X6X6.BFT	3000.32	8X6X6.NFT	5914.43
8X6X4	1	1	12700	8X6X4.BFT	5086.31	8X6X4.NFT	6440.51
8X8X6	1	1	15500	8X6.BFT	2496.44	8X6.NFT	5526.57
8X8X4	1	1	14400	8X4.BFT	2999.84	8X4.NFT	5633.52
10X8X8	1	1	23600	10X8X8.BFT	6307.46	10X8X8.NFT	10717.87
10X8X10	1	1	24900	10X8X10.BFT	9108.02		
12X12X4	1	1	34100	12X4.BFT	9385.07		
10X10X12	1	1	34200	10X12.BFT	9785.20	10X12.NFT	17184.19
10X10X8	1	1	24900	10X8.BFT	5706.82	10X8.NFT	10717.87
10X10X6	1	1	22900	10X6.BFT	6636.93	10X6.NFT	10725.76
10X10X4	1	1	22000	10X4.BFT	6481.45	10X4.NFT	10764.52
12X10X10	1	1	34200	12X10X10.BFT	3220.81		
12X12X10	1	1	36700	12X10.BFT	9877.79	12X10.NFT	16253.03
12X12X8	1	1	36700	12X8.BFT	10020.47	12X8.NFT	16253.03
12X12X6	1	1	35700	12X6.BFT	8468.90	12X6.NFT	16253.03

**FLANGED BASE
TEES**

DESCRIPTION	PCS PER BOX	PCS PER MASTER	WEIGHT PER 100	PART # BLACK	PRICE (US\$) BLACK	PART # GALV.	PRICE (US\$) GALV.
3	1	1	3800	3.BFBT	1573.90	3X2D.NFT	2146.72
4	1	1	3400	4.BFBT	1232.03	3X2.NFT	2139.60
6	1	1	8300	6.BFBT	3205.62	4X6.NFT	4209.97
8	1	1	5900	8.BFBT	1660.00	4X3.NFT	2880.13
10	1	1	5500	10.BFBT	3969.66		
12	1	1	5500	12.BFBT	1812.86	4X2D.NFT	3013.14



FLANGED CROSSES

DESCRIPTION	PCS PER BOX	PCS PER MASTER	WEIGHT PER 100	PART # BLACK	PRICE (US\$) BLACK	PART # GALV.	PRICE (US\$) GALV.
2	1	1	3000	2.BFCR	1701.67		
2-1/2	1	1	4100	2D.BFCR	1507.44	2D.NFCR	2715.14
3	1	1	5000	3.BFCR	1582.85	3.NFCR	2624.50
4	1	1	8200	4.BFCR	2067.54	4.NFCR	3588.66
6	1	1	13400	6.BFCR	4330.04	6.NFCR	5848.18
8	1	1	21300	8.BFCR	6973.78	8.NFCR	9007.64
10	1	1	33000	10.BFCR	8272.85	10.NFCR	14625.24
12	1	1	46000	12.BFCR	12620.23	12.NFCR	22165.71



FLANGED REDUCING CROSSES

DESCRIPTION	PCS PER BOX	PCS PER MASTER	WEIGHT PER 100	PART # BLACK	PRICE (US\$) BLACK	PART # GALV.	PRICE (US\$) GALV.
6X4	1	1	11900	6X4.BFCR	2925.61	6X4.NFCR	4776.15
8X6	1	1	18400	8X6.BFCR	4523.82	8X6.NFCR	7383.16



FLANGED LATERAL

DESCRIPTION	PCS PER BOX	PCS PER MASTER	WEIGHT PER 100	PART # BLACK	PRICE (US\$) BLACK	PART # GALV.	PRICE (US\$) GALV.
2-1/2	1	1	3400	2D.BFLAT	2120.63	2D.NFLAT	3120.83
3	1	1	4500	3.BFLAT	2268.45	3.NFLAT	3016.46
4	1	1	7700	4.BFLAT	2961.23	4.NFLAT	3999.35
6	1	1	13000	6.BFLAT	4505.04	6.NFLAT	6826.14
8	1	1	21300	8.BFLAT	7381.83	8.NFLAT	10118.93
10	1	1	33500	10.BFLAT	9530.09	10.NFLAT	16729.21
12	1	1	51500	12.BFLAT	14680.29		



**WARDLOX TEES
SLIP X SLIP X SLIP**

DESCRIPTION	PCS PER BOX	PCS PER MASTER	WEIGHT PER 100	PART # BLACK	PRICE (US\$) BLACK	PART # GALV.	PRICE (US\$) GALV.
1X1X1	12	12	289	1.BWST	89.09	1.NWST	105.73
1-1/4 X 1-1/4 X 1-1/4	12	12	366	1B.BWST	89.09	1B.NWST	107.80
1-1/2 X 1-1/2 X 1-1/2	12	12	388	1D.BWST	90.51	1D.NWST	117.91
2 X 2 X 2	4	4	641	2.BWST	124.31	2.NWST	159.15



**WARDLOX REDUCING OUTLET TEES
SLIP X SLIP X SLIP**

DESCRIPTION	PCS PER BOX	PCS PER MASTER	WEIGHT PER 100	PART # BLACK	PRICE (US\$) BLACK	PART # GALV.	PRICE (US\$) GALV.
2X2X1	8	8	467	2X1.BWST	108.90	2X1.NWST	134.93
2X2X1-1/4	5	5	529	2X1B.BWST	108.90	2X1B.NWST	134.93
2X2X1-1/2	5	5	593	2X1D.BWST	108.90	2X1D.NWST	134.93



**WARDLOX BULLHEAD TEES
SLIP X SLIP X SLIP**

DESCRIPTION	PCS PER BOX	PCS PER MASTER	WEIGHT PER 100	PART # BLACK	PRICE (US\$) BLACK	PART # GALV.	PRICE (US\$) GALV.
1-1/2 X 1-1/2 X 2	5	5	535	1DX2.BWST	108.90	1DX2.NWST	134.93



**WARDLOX REDUCING OUTLET TEES
SLIP X SLIP X THREAD**

DESCRIPTION	PCS PER BOX	PCS PER MASTER	WEIGHT PER 100	PART # BLACK	PRICE (US\$) BLACK	PART # GALV.	PRICE (US\$) GALV.
1X1X1/2	20	20	200	1XD.BWT	61.07	1XD.NWT	75.32
1X1X3/4	20	20	196	1XE.BWT	61.07	1XE.NWT	79.84
1X1X1	20	20	174	1.BWT	61.07	1.NWT	79.84
1-1/4X1-1/4X1/2	15	15	249	1BXD.BWT	61.07	1BXD.NWT	79.84
1-1/4X1-1/4X3/4	15	15	256	1BXE.BWT	61.07	1BXE.NWT	75.32
1-1/4X1-1/4X1	15	15	240	1BX1.BWT	61.07	1BX1.NWT	79.84
1-1/2X1-1/2X1/2	15	15	298	1DXD.BWT	64.68	1DXD.NWT	80.47
1-1/2X1-1/2X3/4	10	10	292	1DXE.BWT	64.68	1DXE.NWT	85.30
1-1/2X1-1/2X1	10	10	285	1DX1.BWT	64.68	1DX1.NWT	70.04
2X2X1/2	9	9	402	2XD.BWT	79.19	2XD.NWT	98.80
2X2X3/4	9	9	393	2XE.BWT	79.19	2XE.NWT	104.73
2X2X1	9	9	366	2X1.BWT	79.19	2X1.NWT	104.73



**WARDLOX REDUCING RUN & OUTLET TEES
SLIP X SLIP X THREAD**

DESCRIPTION	PCS PER BOX	PCS PER MASTER	WEIGHT PER 100	PART # BLACK	PRICE (US\$) BLACK	PART # GALV.	PRICE (US\$) GALV.
1-1/4X1X1/2	15	15	233	1BX1XD.BWT	65.32	1BX1XD.NWT	80.47
1-1/4X1X3/4	15	15	240	1BX1XE.BWT	53.62		
1-1/4X1X1	15	15	236	1BX1X1.BWT	65.32	1BX1X1.NWT	75.74
1-1/2X1-1/4X1/2	10	10	276	1DX1BXD.BWT	69.30	1DX1BXD.NWT	90.84
1-1/2X1-1/4X3/4	10	10	288	1DX1BXE.BWT	69.30	1DX1BXE.NWT	90.84
1-1/2X1-1/4X1	10	10	272	1DX1BX1.BWT	69.30	1DX1BX1.NWT	74.60
2X1-1/2X1/2	9	9	381	2X1DXD.BWT	83.82	2X1DXD.NWT	103.94
2X1-1/2X3/4	9	9	372	2X1DXE.BWT	83.82	2X1DXE.NWT	103.94
2X1-1/2X1	9	9	360	2X1DX1.BWT	83.82	2X1DX1.NWT	110.17



**WARDLOX 90° ELBOWS
SLIP X SLIP**

DESCRIPTION	PCS PER BOX	PCS PER MASTER	WEIGHT PER 100	PART # BLACK	PRICE (US\$) BLACK	PART # GALV.	PRICE (US\$) GALV.
1	20	20	206	1.BWL	65.19	1.NWL	70.04
1-1/4	15	15	253	1B.BWL	76.23	1B.NWL	79.85
1-1/2	10	10	290	1D.BWL	83.55	1D.NWL	107.85
2	6	6	415	2.BWL	98.73	2.NWL	128.12



**WARDLOX ADAPTER
ELBOWS SLIP X
THREAD**

DESCRIPTION	PCS PER BOX	PCS PER MASTER	WEIGHT PER 100	PART # BLACK	PRICE (US\$) BLACK	PART # GALV.	PRICE (US\$) GALV.
1X1/2	25	25	150	1XD.BWL	77.79	1XD.NWL	101.86
1X3/4	25	25	138	1XE.BWL	77.79	1XE.NWL	101.86
1X1	25	25	160	1X1.BWL	77.79	1X1.NWL	101.86
1-1/4X1/2	15	15	207	1BXD.BWL	80.48	1BXD.NWL	108.41
1-1/4X3/4	15	15	199	1BXE.BWL	80.48	1BXE.NWL	102.27
1-1/4X1	15	15	188	1BX1.BWL	80.48	1BX1.NWL	102.27
1-1/2X1/2	10	10	248	1DXD.BWL	82.81	1DXD.NWL	114.52
1-1/2X3/4	10	10	236	1DXE.BWL	82.81	1DXE.NWL	114.52
1-1/2 X1	10	10	238	1DX1.BWL	82.81	1DX1.NWL	114.52
2X1/2	9	9	302	2XD.BWL	85.37	2XD.NWL	119.40
2X3/4	9	9	323	2XE.BWL	85.37	2XE.NWL	112.66
2X1	9	9	288	2X1.BWL	85.37	2X1.NWL	119.40



**WARDLOX
COUPLINGS
SLIP X SLIP**

DESCRIPTION	PCS PER BOX	PCS PER MASTER	WEIGHT PER 100	PART # BLACK	PRICE (US\$) BLACK	PART # GALV.	PRICE (US\$) GALV.
1X1	25	25	154	1.BWC	58.37	1.NWC	76.01
1-1/4X1-1/4	15	15	227	1B.BWC	58.37	1B.NWC	62.41
1-1/2X1-1/2	15	15	261	1D.BWC	73.40	1D.NWC	75.04
2X2	10	10	360	2.BWC	73.40	2.NWC	99.15

**WARDLOX
GASKETS
SLIP X SLIP**

DESCRIPTION	PCS PER BOX	PCS PER MASTER	WEIGHT PER 100	PART # BLACK	PRICE (US\$) BLACK	PART # GALV.	PRICE (US\$) GALV.
1	25	25	2.9			1.WG	16.74
1-1/4	25	25	3			1B.WG	19.59
1-1/2	25	25	3.1			1D.WG	23.27
2	1	1	3.2			2.WG	24.60

**WARDLOX BOLT/
SOCKETS**

DESCRIPTION	PCS PER BOX	PCS PER MASTER	WEIGHT PER 100	PART # BLACK	PRICE (US\$) BLACK	PART # GALV.	PRICE (US\$) GALV.
3/8 Square Head	1500	1500	4	WB	6.94		

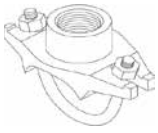

TEELOX MECHANICAL BRANCH CONNECTOR

DESCRIPTION	PCS PER BOX	PCS PER MASTER	WEIGHT PER 100	PART # BLACK	PRICE (US\$) BLACK	PART # GALV.	PRICE (US\$) GALV.
1-1/4X1/2	25	25	98	1BXD.BTLX	14.21	1BXD.NTLX	27.09
1-1/4X3/4	25	25	99	1BXE.BTLX	14.21	1BXE.NTLX	27.09
1-1/4X1	25	25	108	1BX1.BTLX	17.73	1BX1.NTLX	28.56
1-1/2X1/2	25	25	98	1DXD.BTLX	14.21	1DXD.NTLX	28.56
1-1/2X3/4	25	25	99	1DXE.BTLX	14.21	1DXE.NTLX	28.56
1-1/2X1	25	25	108	1DX1.BTLX	17.73	1DX1.NTLX	28.56
2X1/2	25	25	96	2XD.BTLX	14.21	2XD.NTLX	28.56
2X3/4	25	25	85	2XE.BTLX	14.21	2XE.NTLX	28.56
2X1	25	25	99	2X1.BTLX	17.73	2X1.NTLX	29.82
2-1/2X1/2	25	25	121	2DXD.BTLX	14.21	2DXD.NTLX	33.31
2-1/2X3/4	25	25	120	2DXE.BTLX	14.21	2DXE.NTLX	33.31
2-1/2X1	25	25	111	2DX1.BTLX	17.73	2DX1.NTLX	54.27

SPECIFICATIONS

DESCRIPTION	A	B	C
1-1/4X1/2	2	1-1/2	1-3/16
1-1/4X3/4	2-1/16	1-1/2	1-3/16
1-1/4X1	2-1/8	1-1/2	1-3/16
1-1/2X1/2	2	1-1/2	1-3/16
1-1/2X3/4	2-1/16	1-1/2	1-3/16
1-1/2X1	2-1/8	1-1/2	1-3/16
2X1/2	2-5/16	1-13/16	1-3/16
2X3/4	2-3/8	1-13/16	1-3/16
2X1	2-7/16	1-13/16	1-3/16
2-1/2X1/2	2-9/16	2-1/16	1-3/16
2-1/2X3/4	2-11/16	2-1/8	1-3/16
2-1/2X1	2-3/4	2-1/8	1-3/16

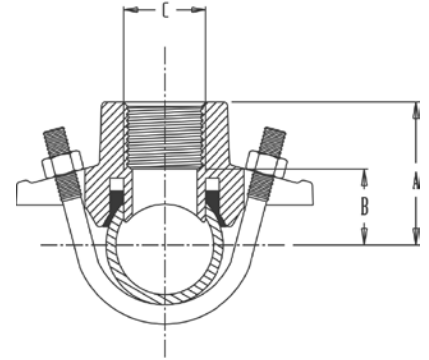

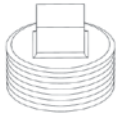

STEEL SQUARE HEAD PLUGS

DESCRIPTION	PCS PER BOX	PCS PER MASTER	WEIGHT PER 100	PART # BLACK	PRICE (US\$) BLACK	PART # GALV.	PRICE (US\$) GALV.		
1/8"	100	600	2	A.BSP	*	0.62	A.NSP	*	0.63
1/4"	100	600	4	B.BSP	*	0.81	B.NSP	*	0.88
3/8"	75	450	6	C.BSP	*	1.12	C.NSP	*	1.16
1/2"	50	300	12	D.BSSP	*	1.87	D.NSSP	*	2.11
3/4"	50	200	18	E.BSSP	*	2.65	E.NSSP	*	3.03

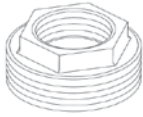

STEEL HEXAGON BUSHINGS

DESCRIPTION	PCS PER BOX	PCS PER MASTER	WEIGHT PER 100	PART # BLACK	PRICE (US\$) BLACK	PART # GALV.	PRICE (US\$) GALV.		
1/4" X 1/8"	25	150	2	BXA.BSB	*	1.72	BXA.NSB		1.78
3/8" X 1/8"	25	150	5	CXA.BSB	*	2.03	CXA.NSB	*	2.20
3/8" X 1/4"	25	150	4	CXB.BSB	*	2.03	CXB.NSB		2.20
1/2" X 1/8"	25	150	8	DXA.BSB	*	3.64	DXA.NSB		3.53
1/2" X 1/4"	25	150	7	DXB.BSB	*	3.17	DXB.NSB	*	3.53
1/2" X 3/8"	25	150	6	DXC.BSB	*	3.17	DXC.NSB	*	3.53
3/4" X 1/8"	50	200	20	EXA.BSB	*	4.93	EXA.NSB	*	5.53
3/4" X 1/4"	50	200	16	EXB.BSB	*	4.93	EXB.NSB	*	5.53
3/4" X 3/8"	50	200	14	EXC.BSB	*	4.93	EXC.NSB	*	5.53
3/4" X 1/2"	50	200	10	EXD.BSB	*	4.93	EXD.NSB	*	5.53
1" X 1/8"	25	100	35	1XA.BSB	*	5.37	1XA.NSB	*	5.83
1" X 1/4"	25	100	31	1XB.BSB	*	5.37	1XB.NSB	*	6.18
1" X 3/8"	25	100	30	1XC.BSB	*	5.37	1XC.NSB	*	6.18
1" X 1/2"	25	100	25	1XD.BSB	*	5.37	1XD.NSB	*	6.18
1" X 3/4"	25	100	15	1XE.BSB	*	5.37	1XE.NSB	*	6.18



STEEL FLUSH BUSHINGS

DESCRIPTION	PCS PER BOX	PCS PER MASTER	WEIGHT PER 100	PART # BLACK	PRICE (US\$) BLACK	PART # GALV.	PRICE (US\$) GALV.		
1/4" X 1/8"	25	150	1	BXA.BFB		1.82	BXA.NFB		1.90
3/8" X 1/4"	25	150	1	CXB.BFB		2.11	CXB.NFB		2.39
1/2" X 1/8"	25	150	5	DXA.BFB		4.55			
1/2" X 1/4"	25	150	3	DXB.BFB		4.83	DXB.NFB		5.79
1/2" X 3/8"	25	150	2	DXC.BFB		4.83	DXC.NFB		5.79
3/4" X 1/4"	25	150	8	EXB.BFB		6.76	EXB.NFB		8.11
3/4" X 3/8"	25	150	7	EXC.BFB		6.76	EXC.NFB		8.11
3/4" X 1/2"	25	150	5	EXD.BFB	*	6.76	EXD.NFB	*	8.11



STEEL HEX SOCKET PLUGS

DESCRIPTION	PCS PER BOX	PCS PER MASTER	WEIGHT PER 100	PART # BLACK	PRICE (US\$) BLACK	PART # GALV.	PRICE (US\$) GALV.		
1/8"	100	600	1	A.BSHSP	*	0.62	A.NSHSP	*	0.63
1/4"	100	600	2	B.BSHSP	*	0.81	B.NSHSP	*	0.83
3/8"	100	600	3	C.BSHSP	*	1.12	C.NSHSP	*	1.16
1/2"	100	600	7	D.BSHSP	*	1.87	D.NSHSP	*	1.99
3/8"	300	300	10	E.BSHSP	*	2.50	E.NSHSP	*	2.86



STEEL SQUARE HEAD COUNTERSUNK PLUGS

DESCRIPTION	PCS PER BOX	PCS PER MASTER	WEIGHT PER 100	PART # BLACK	PRICE (US\$) BLACK	PART # GALV.	PRICE (US\$) GALV.		
1/4"	100	600	2	B.BCTP	*	0.81	B.NCTP	*	0.88
3/8"	75	450	2	C.BCTP		1.12	C.NCTP		1.16



STEEL CAPS

DESCRIPTION	PCS PER BOX	PCS PER MASTER	WEIGHT PER 100	PART # BLACK	PRICE (US\$) BLACK	PART # GALV.	PRICE (US\$) GALV.		
1/8"	50	300	3	A.BSCAP	*	1.53	A.NSCAP	*	1.61
1/4"	40	240	7	B.BSCAP	*	1.99	B.NSCAP	*	2.13
3/8"	40	240	9	C.BSCAP	*	2.95	C.NSCAP	*	3.22
1/2"	50	200	12	D.BSCAP	*	4.63	D.NSCAP	*	4.63
3/4"	25	150	16	E.BSCAP	*	9.77	E.NSCAP	*	10.80



STEEL REDUCING COUPLINGS

DESCRIPTION	PCS PER BOX	PCS PER MASTER	WEIGHT PER 100	PART # BLACK	PRICE (US\$) BLACK	PART # GALV.	PRICE (US\$) GALV.		
1/4" X 1/8"	25	150	9	BXA.BSC	*	8.65	BXA.NSC	*	10.85

